

JOHANNUS

# ECCLESIA

T-377 / D-477 / D-577

*User Manual*

**ECCLESIA**

The church organ without compromise

---

Manufacturer	Global Organ Group b.v.
Address	Keplerlaan 2 6716 BS EDE
Country	The Netherlands
Telephone	+31 (0)318 63 74 03
E-mail	inform@johannus.com
Website	www.johannus.com
Version	1.1
Date	June 2023

**© 2023 Global Organ Group b.v.**





All rights reserved. Nothing in this publication may be reproduced, stored in a data file or made public in any form or in any way either electronically, mechanically by way of photocopying, recording or in any other way without the prior written permission of Global Organ Group b.v.

---

## CONTENTS

<b>1</b>	<b>SAFETY.....</b>	<b>5</b>
1.1	Safety instructions .....	5
1.2	Symbols on the Instrument .....	6
1.3	Symbols in this manual.....	6
1.4	Transport and storage .....	7
1.5	Cautions and important notes.....	8
1.6	Placement.....	10
1.7	Repairs and data.....	10
1.8	Additional precautions .....	11
<b>2</b>	<b>INSTALLATION .....</b>	<b>12</b>
2.1	Installation and connection .....	12
2.1.1	Ecclesia T-377 .....	12
2.1.2	Ecclesia D-477 / D-577.....	13
2.2	Opening and closing roll cover .....	14
2.3	Adjustable music desk ( <i>Ecclesia D-477, D-577</i> ) .....	14
2.4	Pedal contact calibration .....	14
2.5	Switch on .....	15
<b>3</b>	<b>DESCRIPTION OF THE INSTRUMENT.....</b>	<b>16</b>
3.1	Overview of controls.....	16
3.1.1	Ecclesia T-377 .....	16
3.1.2	Ecclesia D-477.....	17
3.1.3	Ecclesia D-577.....	18
3.2	Connect and switch on the external device(s) .....	19
3.3	External connections .....	19
3.4	External loudspeaker output .....	20
3.5	USB (type A) connection for USB-memory .....	20
<b>4</b>	<b>OPERATION .....</b>	<b>20</b>
4.1	General volume .....	20
4.2	Expression pedals .....	20
4.3	Reverb.....	20
4.4	Organ Style .....	21
4.5	Stops .....	21
4.6	Couplers.....	22
4.7	Accessories .....	23
4.8	Capture memory.....	24
4.8.1	Pre-programmed memory locations (PP – T2) .....	24
4.8.2	Capture memory locations.....	24
4.8.1	Preloads.....	25
4.8.2	Programming a capture memory location .....	25
4.8.3	Calling up a capture memory location .....	25
4.8.4	Memory lock .....	25
4.9	Transposer .....	25
4.10	Crescendo pedal .....	25
4.11	Zimbelstern (optional).....	26
4.12	Quick Access .....	26

---

4.12.1	Programming mode crescendo pedal .....	26
4.12.2	Programming mode MIDI .....	26
4.12.3	Programming mode Orchestral settings .....	26
4.12.4	Programming mode Orchestral settings startup default .....	27
4.12.5	Programming startup mode .....	27
<b>5</b>	<b>JOHANNUS MENU .....</b>	<b>28</b>
5.1	 Audio Settings .....	28
5.2	Backup & Restore .....	28
5.3	Chorus .....	29
5.4	 Crescendo .....	30
5.5	Expression Pedals .....	30
5.6	General Volume .....	31
5.7	Key Volumes .....	31
5.8	Master Pincode .....	33
5.9	Memory Pincode .....	33
5.10	MIDI Config .....	34
5.11	Orchestrals (optional) .....	35
5.12	Reset Procedures .....	36
5.13	Reverb Settings .....	37
5.14	Rotor Speed (optional) .....	37
5.15	Startup Settings .....	38
5.16	 Temperaments .....	38
5.17	 Tuning .....	39
5.18	 USB .....	40
5.19	Version .....	41
<b>6</b>	<b>OPTIONAL ORCHESTRAL PACKAGES .....</b>	<b>42</b>
<b>7</b>	<b>MAINTENANCE, TROUBLESHOOTING AND WARRANTY .....</b>	<b>44</b>
7.1	Maintenance .....	44
7.1.1	Maintenance of the cabinet .....	44
7.1.2	Maintenance of the manuals .....	44
7.2	Problems .....	45
7.3	Warranty .....	45
<b>8</b>	<b>MIDI IMPLEMENTATIONS .....</b>	<b>46</b>
8.1	MIDI Implementation Chart .....	46
8.2	MIDI Specifications .....	47
8.3	Specifications of Instrument .....	49

---

# 1 SAFETY

## 1.1 Safety instructions



- To reduce the risk of fire or electric shock, do not expose the Instrument to liquids, rain or moisture.
- Position the Instrument on a stable, horizontal surface.
- When power cord plug has an earth-pin: Connect the Instrument to an earthed mains (wall) socket-outlet.
- Turn off the Instrument when it is not in use.
- Do not place the Instrument in a damp area.
- Follow the instructions and precautionary measures in this user manual.
- Keep this user manual with the Instrument.
- The Instrument may only be opened by a technician authorized by Global Organ Group B.V. The Instrument contains static-sensitive components. The warranty is void if the Instrument is opened by a non-authorized person.

### NOTICE

1. Read these instructions.
2. Keep these instructions.
3. Heed all warnings.
4. Follow all instructions.
5. Do not use this apparatus near water.
6. Clean only with a dry cloth.
7. Do not block any of the ventilation openings.

Install in accordance with the manufacturer's instructions.

8. Do not install near any heat sources such as radiators, heat registers, stoves, or other apparatus (including amplifiers) that produce heat.
9. When power cord plug has an earth-pin: Do not defeat the safety purpose of the polarized or grounding-type plug.  
A polarized plug has two blades with one wider than the other. A grounding type plug has two blades and a third grounding prong. The wide blade or the third prong are provided for your safety. If the provided plug does not fit into your outlet, consult an electrician for replacement of the obsolete outlet.
10. Protect the power cord from being walked on or pinched particularly at plugs, convenience receptacles, and the point where they exit from the apparatus.
11. Only use attachments/accessories specified by the manufacturer.
12. Unplug this apparatus during lightning storms or when unused for long periods of time.
13. Refer all servicing to qualified service personnel. Servicing is required when the apparatus has been damaged in any way, such as power-supply cord or plug is damaged, liquid has been spilled or objects have fallen into the apparatus, the apparatus has been exposed to rain or moisture, does not operate normally, or has been dropped.

## 1.2 Symbols on the Instrument

 **CAUTION**  
RISK OF ELECTRIC SHOCK  
DO NOT OPEN 

**注意**  
感電の恐れがあります キャビネットをあけないでください

**警告**  
为了避免触电, 请勿自行拆开机壳, 内部无用户自行维修的机件。请交乐兰公司指定维修点进行维修事宜。

**경고** 전기쇼크위험 - 열지 마시오.

**ATTENTION:** RISQUE DE CHOC ELECTRIQUE NE PAS OUVRIR

**WARNING:** TO REDUCE THE RISK OF FIRE OR ELECTRIC SHOCK, DO NOT EXPOSE THIS APPLIANCE TO RAIN OR MOISTURE.

**AVERTISSEMENT:** POUR RÉDUIRE LE RISQUE D'INCENDIE OU DE CHOC ÉLECTRIQUE, N'EXPOSEZ PAS CET APPAREIL À LA PLUIE OU À L'HUMIDITÉ.



- Laite on liitettävä suojamaadoituskoskettimilla varus ettuun pistorasiaan.
- Apparatets stikprop skal tilsluttes en stikkontakt med jord, som giver forbindelse til stikproppens jord
- Apparatet må tilkoples jordet stikkontakt.
- Apparaten skall anslutas till jordat uttag.

THIS DEVICE COMPLIES WITH PART 15 OF THE FCC RULES. OPERATION IS SUBJECT TO THE FOLLOWING TWO CONDITIONS: (1) THIS DEVICE MAY NOT CAUSE HARMFUL INTERFERENCE, AND (2) THIS DEVICE MUST ACCEPT ANY INTERFERENCE RECEIVED, INCLUDING INTERFERENCE THAT MAY CAUSE UNDESIRE OPERATION.

CAN ICES-3(B)/NMB-3(B)

仅适用于非热带气候条件下安全使用  
仅适用于海拔2000m以下地区安全使用



**Warning:** The exclamation point within an equilateral triangle is intended to alert the user to the presence of important operating and maintenance (servicing) instructions in the literature accompanying the product.



The lightning flash with arrowhead symbol, within an equilateral triangle, is intended to alert the user to the presence of uninsulated “dangerous voltage” within the product’s enclosure that may be of sufficient magnitude to constitute a risk of electric shock to persons.



**Warning for static-sensitive components.** To prevent damage to electronic parts from static electricity, be sure to discharge any static electricity from your own body before handling / touching the instrument.

## 1.3 Symbols in this manual



Caution, Warning or important information



Do not, or forbidden to do



Note

---

## 1.4 Transport and storage

Pay attention to the following during transport and storage:

- Remove the music desk and the pedal board from the instrument, before transport.
- Store in an area with 40% to 60% relative humidity.  
Do not store in area's e.g. baths, washrooms, on wet floors, expose to steam or smoke, salt, humid, rain, moisture, dusty or sandy locations.
- Minimum temperature within the storage area: 0°C
- **Do not expose the Instrument to direct sunlight (UV)**, do not place it near devices that radiate heat, or otherwise subject to temperature extremes. Also, do not allow lighting devices that normally are used while their light source is very close to the Instrument (such as a piano light), or powerful spotlights to shine upon the same area of the Instrument for extended periods of time. Excessive heat can deform or discolour the Instrument.
- **Do not allow rubber, vinyl or similar materials to remain on this Instrument for long periods of time.** Such objects can discolour or otherwise harmfully affect the finish.
- **Do not paste stickers, decals, or the like to this instrument.** Peeling such matter off the instrument may damage and or discolour the exterior finish.
- Do not bend the power cord or place heavy objects on it.
- **Don't allow foreign objects or liquids to enter Instrument;**  
**Never place containers with liquid on Instrument;** Do not put anything that contains water on this Instrument. Also, avoid the use of insecticides, perfumes, alcohol, nail polish, spray cans, etc., near the Instrument. Swiftly wipe away any liquid that spills on the Instrument using a dry, soft cloth. Never use benzene, thinners, alcohol or solvents of any kind, to avoid the possibility of discoloration and/or deformation.
- **Unplug the power cord from the outlet before cleaning.** Before cleaning the Instrument, turn it off and unplug the power cord from the outlet. To clean the Instrument, use a dry, soft cloth; or one that is slightly dampened. Try to wipe the entire surface using an equal amount of strength, moving the cloth along with the grain of the wood. Rubbing too hard in the same area can damage the finish.
- **Do not open. Do not disassemble or modify by yourself**
- **Avoid climbing on top of the Instrument, or placing heavy objects on it, nor on top of the keyboard nor pedal board. This can lead to dangerous situations** - such as tilting / tipping over - shearing / falling off of heavy objects. This can also lead to malfunctions - such as keys ceasing to produce sound.
- **Do not bend, drop, strong shock or vibration.**
- Never strike or apply strong pressure to the display.
- **Cautions when moving this Instrument:** Since this product is very heavy, you must make sure that a sufficient number of people are on hand to help, so you can lift and move it safely, without causing strain. Make sure to have a firm grip, to protect yourself from injury and the instrument from damage. If you need to move the instrument, consult with your retailer, or Global Organ Group B.V.



---

## 1.5 Cautions and important notes

### Indoor use only.

**Connect the power cord to an outlet of the correct voltage.** The Instrument should be connected to a power supply only of the type described as marked under the keyboard deck of Instrument.



**When power cord plug has an earth-pin: Make sure that this is connected to an earthed mains (wall) socket-outlet.**



**Do not connect or disconnect the power cord with wet hands.** Never handle the power cord or its plugs with wet hands when plugging into, or unplugging from, an outlet.



**Turn off the Instrument if an abnormality or malfunction occurs.** Immediately turn the Instrument off, remove the power cord from the outlet, and request servicing by your retailer, or Global Organ Group B.V., when:



- The power-supply cord or the plug has been damaged; or
- If smoke or unusual odor occurs; or
- Objects have fallen into, or liquid has been spilled onto the Instrument; or
- The Instrument has been exposed to rain (or otherwise has become wet); or
- The Instrument does not appear to operate normally or exhibits a marked change in performance.

**Do not use overseas, foreign countries.** Before using the Instrument in a foreign country, consult with your retailer, or Global Organ Group B.V.



**Presence of children.** For their safety, adults should make sure that children under the age of 16 use the instrument properly and that the Instrument is in a stable position. An adult should always be present to supervise and guide any use by a child. Due to the weight of the instrument, it is recommended that it be securely fixed to the wall or floor by a professional to prevent tipping over. This is despite the fact that all safety precautions have been taken to avoid accidents.



**Do not connect this Instrument to same electrical outlet that is being used by an electrical appliance that is controlled by an inverter or a motor** (such as a refrigerator, washing machine, microwave oven, or air conditioner). Depending on the way in which the electrical appliance is used, power supply noise may cause this Instrument to malfunction or may produce audible noise. If it is not practical to use a separate electrical outlet, connect a power supply noise filter between this Instrument and the electrical outlet.



**Do not share an outlet with an unreasonable number of other devices.** Do not force the Instrument's power-supply cord to share an outlet with an unreasonable number of other devices. Be especially careful when using extension cords—the total power used by all devices you have connected to the extension cord's outlet must never exceed the power rating (watts/amperes) for the extension cord. Excessive loads can cause the insulation



on the cord to heat up and eventually melt through - therefore always completely unwind an extension cord.

**Energy consumption:** By using efficient, energy-saving technology (internal LEDs, switching power supplies and amplifiers), a high efficiency is achieved. The instrument is equipped with a AC mains power switch that switches off the instrument completely, so that no (standby) power is consumed in the off position.





**To prevent malfunction and equipment failure, always make sure to turn off the power on all your equipment before you make any connections.**



Although the LCD and LEDs are switched off when the Instrument is turned off, this does not mean that the Instrument has been completely disconnected from the source of power. If you need to turn off the power completely, first turn off the Instrument's switch, then unplug the power cord from the power outlet. For this reason, the outlet into which you choose to connect the power cord's plug should be one that is within easy reach and readily accessible.



If there is a possibility of lightning strike, disconnect the power cord from the outlet. Whenever you suspect the possibility of lightning in your area, pull the plug on the power cord out of the outlet.



**Periodically clean the power cord's plug.** At regular intervals, you should unplug the power plug and clean it by using a dry cloth to wipe all dust and other accumulations away from its prongs. Also, disconnect the power plug from the power outlet whenever the Instrument is to remain unused for an extended period of time. Any accumulation of dust between the power plug and the power outlet can result in poor insulation and lead to fire.



**The settings you were editing will be lost when the Instrument is turned off.** If you want to keep your settings, you must save your settings before turning the Instrument off.



**Place in a well ventilated location.** The Instrument should be located so that its location or position does not interfere with its proper ventilation.



**Manage cables for safety.** Try to prevent cords and cables from becoming entangled. Also, all cords and cables should be placed so they are out of the reach of children.



**Grasp the plug when connecting or disconnecting the power cord.** Always grasp only the plug on the power-supply cord when plugging into, or unplugging from, an outlet.



**Precautions concerning use of bench.** When using the bench, please observe the following points:

- Do not allow two or more persons to sit on the bench.
- Do not adjust the height while sitting on the bench.



**Do not remove the speaker grille and speaker.** Do not remove the speaker grille and speaker by any means. Speaker not user replaceable. Shock hazardous voltages and currents are present inside the enclosure.



**Disconnecting power from AC mains.** To completely disconnect this apparatus from the AC mains, disconnect the power supply cord plug from the AC receptacle.



**The power supply cord and/or main power switch must be accessible.** The mains plug of the power supply cord shall remain readily accessible. Or, the power switch must be accessible. The main power switch is the main power disconnect device for this Instrument.



Therefore, the power switch shall be readily accessible.

**Do not use internal connections.** Do not connect, do not use internal connections for optional external speakers by yourself. Refer all servicing to your retailer, or Global Organ Group B.V.



---

## 1.6 Placement

- Using the Instrument near power amplifiers (or other equipment containing large power transformers) may induce hum. To alleviate the problem, change the orientation of this Instrument; or move it farther away from the source of interference.
- This device may interfere with radio and television reception. Do not use this device in the vicinity of such receivers.
- Noise may be produced if wireless communications devices, such as cell phones, are operated in the vicinity of this Instrument. Such noise could occur when receiving or initiating a call, or while conversing. Should you experience such problems, you should relocate such wireless devices so they are at a greater distance from this Instrument, or switch them off.
- **Do not expose the Instrument to direct sunlight**, place it near devices that radiate heat, or otherwise subject it to temperature extremes. Also, do not allow lighting devices that normally are used while their light source is very close to the Instrument (such as a piano light), or powerful spotlights to shine upon the same area of the Instrument for extended periods of time. Excessive heat can deform or discolour the Instrument.
- **Do not allow rubber, vinyl, or similar materials to remain on this Instrument for long periods of time.** Such objects can discolour or otherwise harmfully affect the finish.
- **Do not allow objects to remain on top of the keyboard or pedal board.** This can be the cause of malfunction, such as keys ceasing to produce sound.
- **Do not paste stickers, decals, or the like to this instrument.** Peeling such matter off the instrument may damage the exterior finish.
- **Do not put anything that contains water on this Instrument.** Also, avoid the use of insecticides, perfumes, alcohol, nail polish, spray cans, etc., near the Instrument. Swiftly wipe away any liquid that spills on the Instrument using a dry, soft cloth.
- Due to the weight of the instrument, it is recommended to attach the instrument securely to the wall or floor by a professional, to avoid tipping. This, although all safety measures have been taken to avoid any accident.



## 1.7 Repairs and data

Please be aware that all data contained in the Instrument's memory may be lost when the Instrument is sent for repairs. Important data should always be stored, written down on paper (when possible).



During repairs, due care is taken to avoid the loss of data. However, in certain cases (such as when circuitry related to memory itself is out of order), we regret that it may not be possible to restore the data, and Global Organ Group B.V. assumes no liability concerning such loss of data. Refer all servicing to your retailer, or Global Organ Group B.V.

---

## 1.8 Additional precautions

- Please be aware that the contents of memory can be irretrievably lost as a result of a malfunction, or the improper operation of the Instrument. To protect yourself against the risk of losing important data, we recommend that you periodically write down important setting data (when possible).
- Unfortunately, it may be impossible to restore the contents of data that was stored in the Instrument's memory once it has been lost. Global Organ Group B.V. assumes no liability concerning such loss of data.
- Use a reasonable amount of care when using the Instrument's buttons, sliders, or other controls; and when using its jacks and connectors. Rough handling can lead to malfunctions.
- Never strike or apply strong pressure to the display.
- A small amount of heat will radiate from the Instrument during normal operation.
- To prevent possible hearing damage, do not listen at high volume levels for long periods. This Instrument, either alone or in combination with an amplifier and headphones or speakers, may be capable of producing sound levels that could cause permanent hearing loss. Do not operate for a long period of time at a high volume level, or at a level that is uncomfortable. If you experience any hearing loss or ringing in the ears, you should immediately stop using the Instrument, and consult an audiologist.
- To avoid disturbing others nearby, try to keep the Instrument's volume at reasonable levels. You may prefer to use headphones, so you do not need to be concerned about those around you.
- When you need to transport the Instrument, pack it in shock-absorbent material. Transporting the Instrument without doing so can cause it to become scratched or damaged, and could lead to malfunction.
- Do not apply undue force to the music stand while it is in use.
- Some connection cables contain resistors. Do not use cables that incorporate resistors for connecting to this Instrument. The use of such cables can cause the sound level to be extremely low, or impossible to hear. For information on cable specifications, contact the manufacturer of the cable.
- Due to the structural design of this instrument, small pets or other animals could end up getting trapped inside it. If such a situation is encountered, you must immediately turn off the Instrument and disconnect the power cord from the outlet. You should then consult with the retailer from whom the instrument was purchased, or contact Global Organ Group B.V.
- The explanations in this manual include illustrations that depict what should typically be shown by the display.
- Note, however, that your Instrument may incorporate a newer, enhanced version of the system (e.g., includes newer sounds), so what you actually see in the display may not always match what appears in the manual.



---

## 2 INSTALLATION

### 2.1 Installation and connection



*Shown model: Ecclesia T-377 with Symphony Voice Package*

#### **Installing loudspeakers:**

The external loudspeakers have to be installed by an authorized Johannes installer.

#### **Installing console:**

1. Position the Instrument on a stable, horizontal surface.
2. Lean the Instrument slightly backward.
3. Slide the pedal board (E) against the Instrument.
4. Set the Instrument upright.
5. Put the music desk (A) in the groove (B) on the cover of the Instrument.
6. Place the Instrument bench (D) over the pedal board.
7. Make sure the voltage marked on the serial plate (C) of the Instrument matches the local mains voltage.
8. When power cord plug has an earth-pin: Connect the Instrument to a earthed mains (wall) socket-outlet.
9. Perform a pedal contact calibration. See § 2.4.

---

### 2.1.2 Ecclesia D-477 / D-577



*Shown model: Ecclesia D-577 with Symphony Voice Package*

#### **Installing loudspeakers:**

The external loudspeakers have to be installed by an authorized Johannes installer.

#### **Installing console:**

1. Position the Instrument on a stable, horizontal surface.
2. Lean the Instrument slightly backward.
3. Slide the pedal board (E) against the Instrument.
4. Set the Instrument upright.
5. Put the music desk (A) in the appropriate slots (B). These slots are in the outside of the cabinets with draw stops.
6. Place the Instrument bench (D) over the pedal board.
7. Make sure the voltage marked on the serial plate (C) of the Instrument matches the local mains voltage.
8. When power cord plug has an earth-pin: Connect the Instrument to a earthed mains (wall) socket-outlet.
9. Perform a pedal contact calibration. See § 2.4.

---

## 2.2 Opening and closing roll cover

The Instrument can be closed with a wooden roll cover that has a lock. The roll cover lock is positioned behind the music desk.



The Ecclesia D-577 has a roll cover that has no lock. All instructions related to the roll cover lock are not applicable to the Ecclesia D-577.

### Opening

- Put the key in the roll cover lock.
- Turn the key a quarter turn to the left. The lock now comes out.
- Slide the roll cover upwards.



Never leave the key in the area that can be closed!  
It is recommended to leave the key in the lock.

### Closing

- Slide the roll cover downwards.
- Press the roll cover lock in.
- Turn the key a quarter turn to the right.

## 2.3 Adjustable music desk (Ecclesia D-477, D-577)

The music desk is adjustable in depth and in height.



Do not adjust the music desk with music books on it.

To adjust the depth, grasp the music desk on both sides and pull it towards you or push it away from you.



Do not pull the music desk too far towards you so that the music desk supports are drawn out of the support slides.

To adjust the height, squeeze the clamps behind the music desk on both sides and shift the height.

## 2.4 Pedal contact calibration

Perform a pedal contact calibration after installing or moving an Instrument. First activate one or more pedal stops, make sure the Instrument produces sound.

1. Check if pedal board is tightly pressed against the Instrument and the Instrument stands on a stable, horizontal surface. Check if each pedal key produces sound at the desired key depth. Follow steps below when the pedal board appears un-even or partially not functioning:

2. Remove the Instrument bench and slide the pedal board away from the the Instrument. It may be necessary to lean the Instrument slightly backwards to do this.
3. Now the pedal position set screws on both sides of the Instrument are visible, see image below. These set screws are to adjust the pedal key depth.

*Example image - set screws are to adjust the pedal key depth*

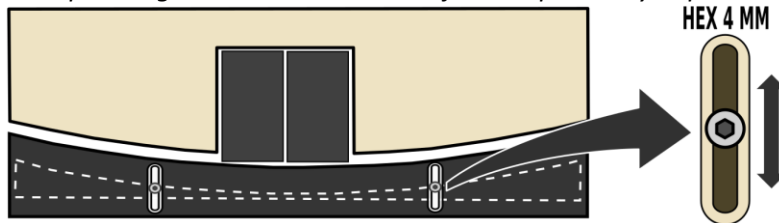

Loosen the set screws a little to adjust the positions a little upwards, or downwards. This moves the magnetically sensitive pedal contact position relative to the pedal key magnets of the pedal board. Tighten the set screws at the new pedal key depth position – and remember the set positions.

4. Lean the Instrument slightly backward to slide the pedal board against the Instrument and set the Instrument upright afterwards.
5. If you want, place the Instrument bench over the pedal board.
6. Repeat step 1 to check the difference and repeat steps 2 to 5 when further improvement is needed.

## 2.5 Switch on

Switch on the Instrument with the on/off piston at the right, next to the manuals. Wait several seconds. Starting the control functions and the settings will take some time. The lights of the as standard set functions lit up. The settings appear on the display.

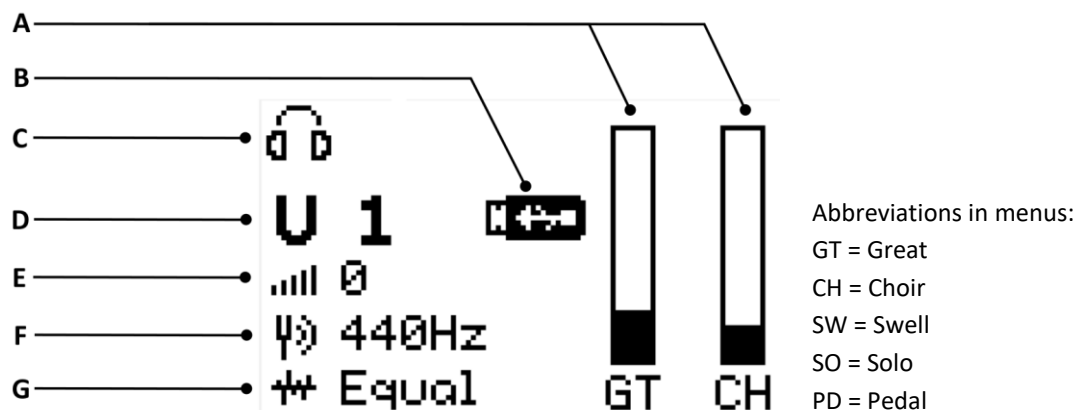

The display shows symbols of the main menu:

- A Positions of Expression pedals – see § 4.2
- B Visible that USB-memory is inserted, recognized and can be used – see § 3.5
- C Visible that Headphones plug is connected – see § 3.3.
- D Capture memory location – see § 4.8.2.
- E Visible when active, with visible crescendo step – see § 4.2, § 4.10.
- F Tuning – see § 5.17
- G Temperament – see § 5.16

### 3 DESCRIPTION OF THE INSTRUMENT

#### 3.1 Overview of controls

##### 3.1.1 Ecclesia T-377

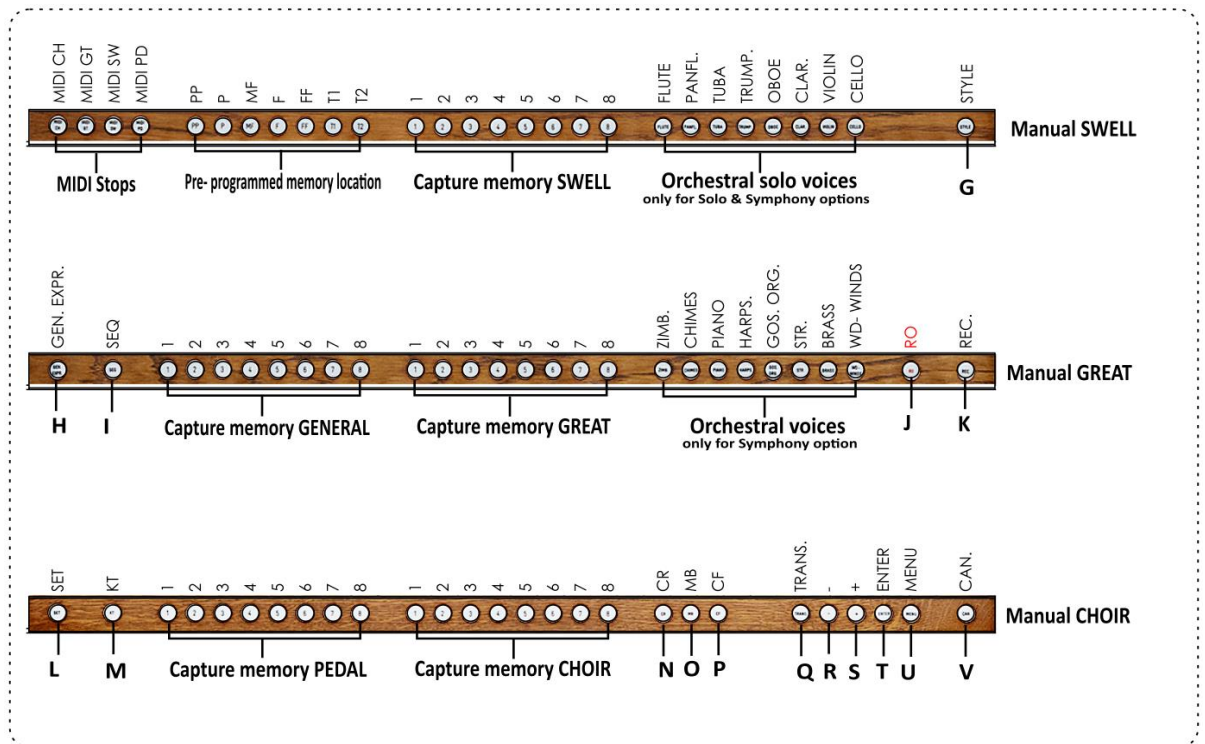
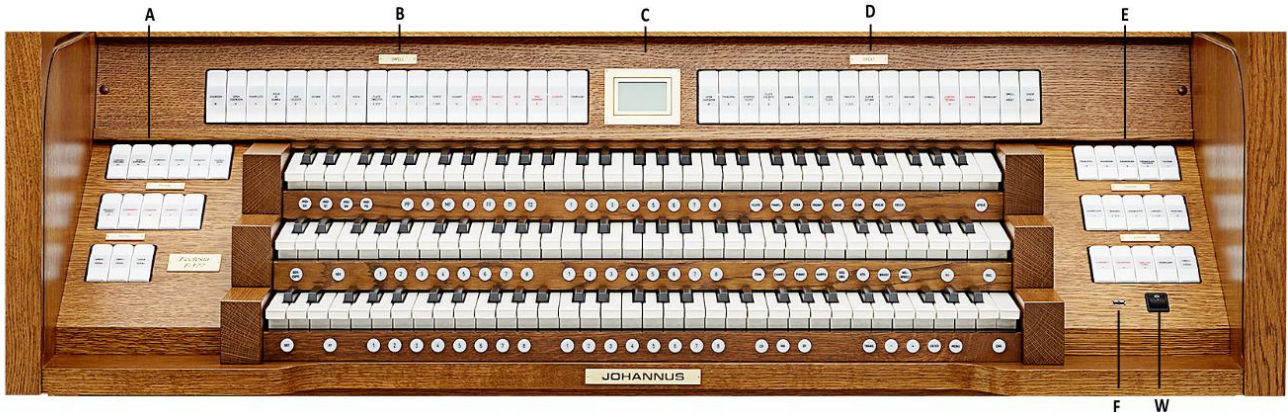

- A Pedal stops and coupler
- B Swell stops and coupler
- C Display
- D Great stops and coupler
- E Choir stops and coupler
- F USB-memory connection
- G Style (see §4.4)
- H General Expression
- I SEQ: Sequence piston (see §4.7)
- J RO: Reeds Off (see §4.7)
- K REC: Recall
- L SET
- M KT: Keyboard Transfer (see §4.7)

- N CR: Crescendo
- O MB: Manual Bass (see §4.6)
- P CF : Cantus Firmus (see §4.6)
- Q TRANS. : Transposer (see §4.7)
- R - piston
- S + piston
- T ENTER
- U MENU (see §5)
- V CAN: Cancel piston
- W AC-MAINS switch On/Off piston

**Optional Solo and Symphony Voice Package:**  
 - Orchestral solo voices (Solo and Symphony package)  
 - Orchestral voices (Symphony package only)



### 3.1.2 Ecclesia D-477

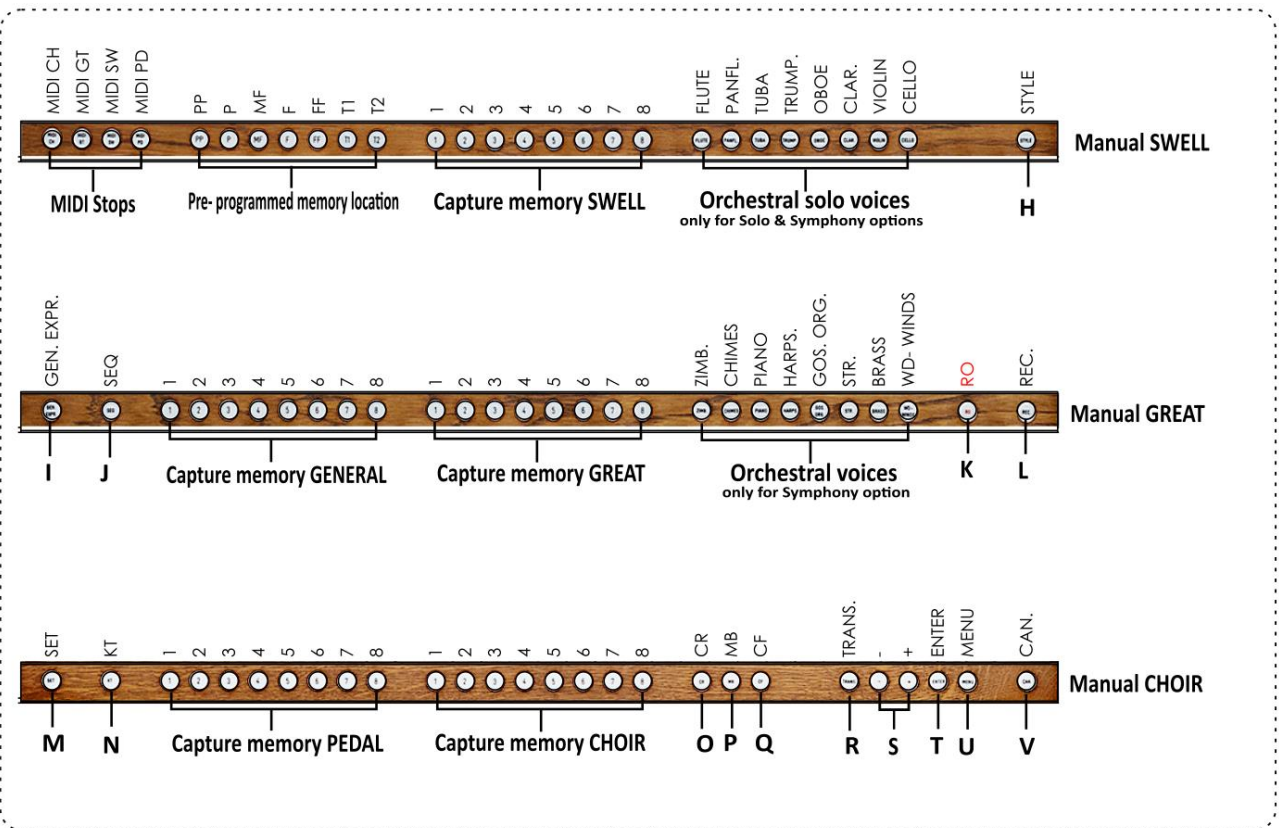
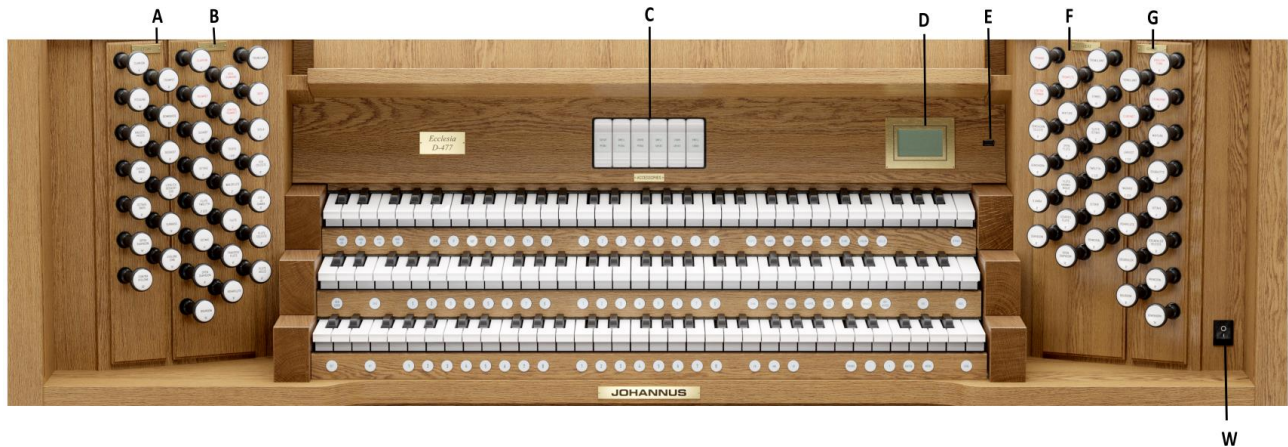

- A** Pedal stops
- B** Swell stops
- C** Couplers
- D** Display
- E** USB-memory connection
- F** Great stops
- G** Choir stops
- H** Style (see §4.4)
- I** General Expression
- J** SEQ: Sequence piston (see §4.7)
- K** RO: Reeds Off (see §4.7)
- L** REC: Recall
- M** SET

- N** KT: Keyboard Transfer (see §4.7)
- O** CR: Crescendo
- P** MB: Manual Bass (see §4.6)
- Q** CF : Cantus Firmus (see §4.6)
- R** TRANS. : Transposer (see §4.7)
- S** - and + pistons
- T** ENTER
- U** MENU (see §5)
- V** CAN: Cancel piston
- W** AC-MAINS switch On/Off piston

**Optional Solo and Symphony Voice Package:**  
 - Orchestral solo voices (Solo and Symphony package)  
 - Orchestral voices (Symphony package only)

### 3.1.3 Ecclesia D-577

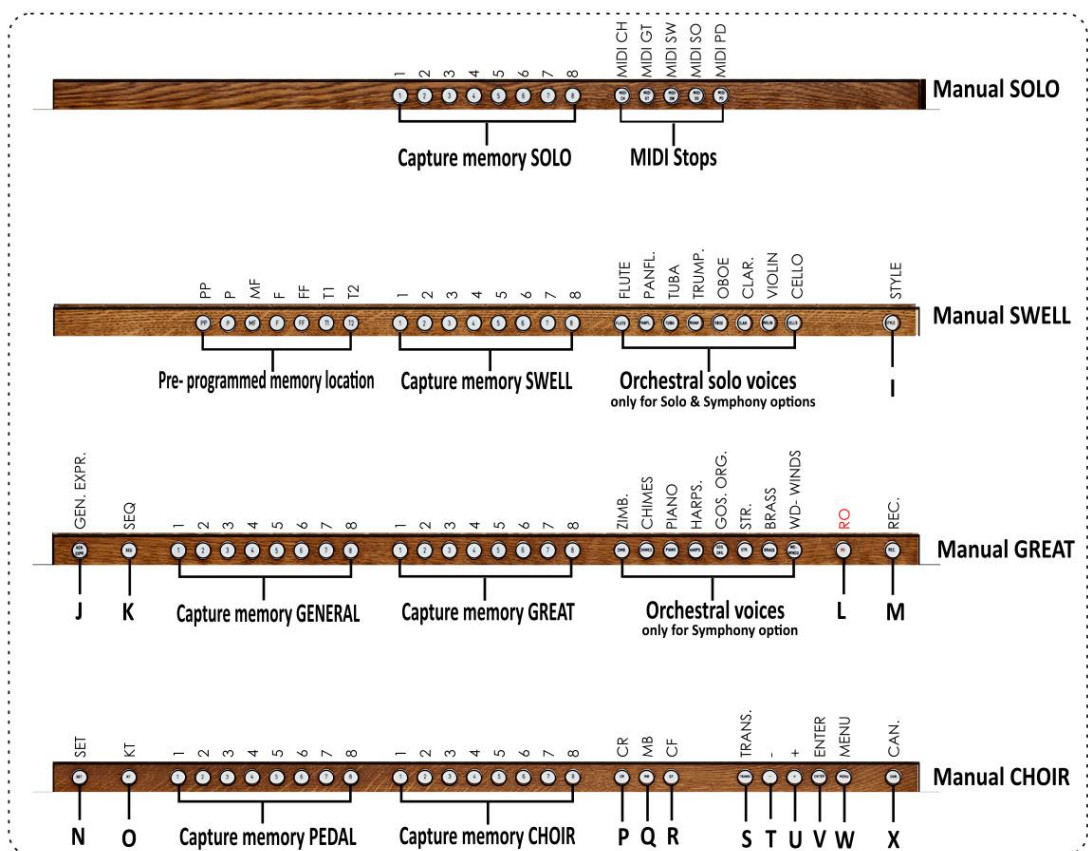
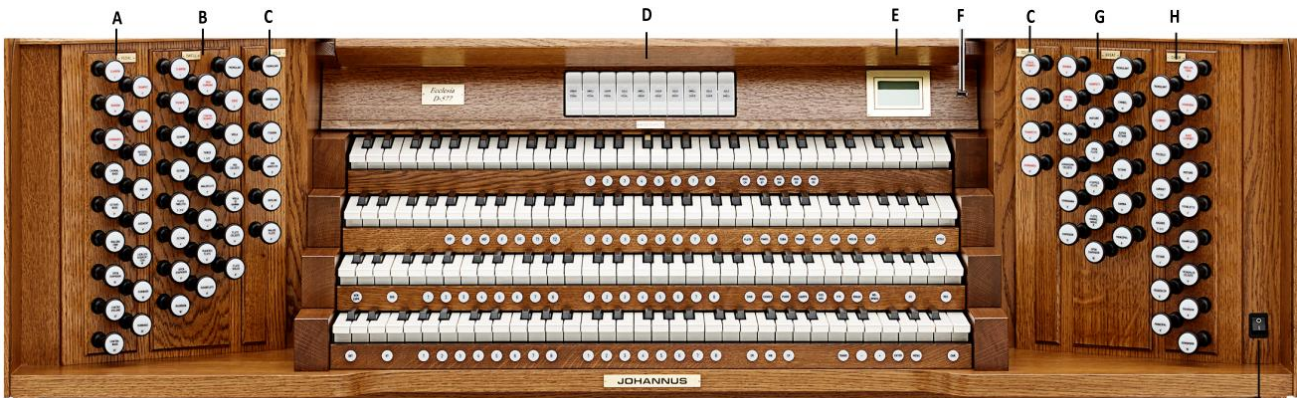

- A Pedal stops
- B Swell stops
- C Solo stops
- D Couplers
- E Display
- F USB-memory connection
- G Great stops
- H Choir stops
- I Style (see §4.4)
- J General Expression
- K SEQ: Sequence piston (see §4.7)
- L RO: Reeds Off (see §4.7)
- M REC: Recall
- N SET
- O KT: Keyboard Transfer (see §4.7)

- P CR: Crescendo
- Q MB: Manual Bass (see §4.6)
- R CF: Cantus Firmus (see §4.6)
- S TRANS.: Transposer (see §4.7)
- T - piston
- U + piston
- V ENTER
- W MENU (see §5)
- X CAN: Cancel piston
- Y AC-MAINS switch On/Off piston

#### Optional Solo and Symphony Voice Package:

- Orchestral solo voices (Solo and Symphony package)
- Orchestral voices (Symphony package only)

### 3.2 Connect and switch on the external device(s)

You can connect external devices (for example, a MIDI device) to the Instrument.



Follow the instructions provided in the documentation for the external device(s).

1. Switch off the Instrument and the external device(s).
2. Connect the external device to the Instrument.
3. Switch on the external device.
4. Switch on the Instrument.

### 3.3 External connections

The external connections are situated below the keyboards, on the left side.

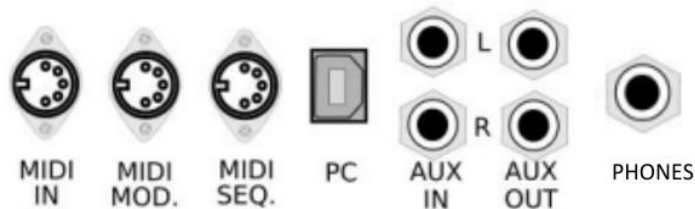

**MIDI IN:** An input for receiving MIDI codes from other devices.

**MIDI MOD:** A programmable MIDI output for connecting a sound module or expander, for example.

**MIDI SEQ:** A non-programmable MIDI output for connecting a Johannes Sequencer+ or PC, for example.

**PC:** PC USB connection for data transfer (with the optional Johannes Intonat program). Use a short USB2 cable for connection, without an extension cable.

**AUX IN:** A stereo audio input for playing the sound of an external device through the amplifiers of the Instrument. For example, an expander connected to the Instrument through the MIDI MOD can be played through the instrument's loudspeakers.

**AUX OUT:** A stereo audio output for connecting an external device (amplifier or recording device, for example).

 **PHONES:** This connection for a (stereo) headphone is suited for a headphone with an impedance of 30  $\Omega$  or more (see headphone specifications).



When the headphone is used, the loudspeakers of the Instrument are switched off automatically. The headphones symbol  will be visible on the display.

---

### 3.4 External loudspeaker output

The external loudspeaker outputs (8 Ω) are situated inside the cabinet of the Instrument, see §8.3 Specifications of Instrument. Connect the loudspeaker cables to the connectors of the loudspeaker output during installation of the Instrument by a professional only.

### 3.5 USB (type A) connection for USB-memory

The USB type A, for USB-memory. This USB-connection is suitable to connect USB-memory to save settings, memory locations or for service purposes, see §3.5, §5.2 and §5.18. This connection is automatically disabled when the USB port (type B) for PC-connection is used see §3.3.

## 4 OPERATION

### 4.1 General volume

The general volume of the Instrument can be adjusted with use of the Menu, see § 5.6.

### 4.2 Expression pedals

The Instrument has, four (*Ecclesia T-377 and D-477*) or five (*Ecclesia D-577*) expression pedals. One is configured as a crescendo pedal, the others are configured as swell pedals for the existing divisions. The Pedal division is combined with the Great division.

With use of the Johannus Menu, the function of the expression pedals can be changed, see § 5.5. The behavior of the swell function of the expression pedal can be changed from realistic to linear, see Startup settings § 5.15.

Using an expression pedal which is set as a swell pedal will next to the volume also changes the timbre of the stops. By this the effect of the swell box shutters of a pipe organ is simulated.

### 4.3 Reverb

The Instrument is equipped with 12 unique and recorded convolution reverbs of existing venues. By selecting a reverb that blends well with the venue, these reverbs can be used to enhance the sound of the Instrument:

Convolution reverbs	length
Trinity Episcopal Church, Greeley (CO, USA)	1.6 sec
Zuidervemaning, Westzaan (Netherlands)	2.7 sec
First United Methodist Church, Galveston (TX, USA)	2.8 sec
Concert Hall, Worcester (MA, USA)	3.0 sec
First Congregational Church, Los Angeles (CA, USA)	3.2 sec
Redeemer Presbyterian Church, Austin (TX, USA)	3.4 sec
First Baptist Church, Longview (TX, USA)	3.6 sec
Frognerkirke, Oslo (Norway)	4.2 sec

---

Church of the Holy Name , Manchester (United Kingdom)	4.8 sec
Oude Kerk, Amsterdam (Netherlands)	5.2 sec
Notre Dame d'Auteuil, Paris (France)	6.8 sec
Hofkirche, Dresden (Germany)	7.4 sec

With use of the Johannus Menu the reverb settings can be adjusted, see §5.

#### 4.4 Organ Style

The Ecclesia series always comes with two Organ sample styles of your choice. If desired, this can be expanded to six different styles: Symphonic (American and French), Romantic (Dutch and English), and Baroque (North German and South German).

The sample styles can be chosen by pressing the STYLE piston:

1. Press the STYLE-piston. The active Style setting appears on the display.
2. Use the - and + pistons to select a different *Style* function on the display.
3. Press the ENTER-piston to confirm, or MENU-piston to cancel. After the new sample set is loaded, the newly selected Style is activated until the Instrument is switched-off. When you want the active style as default startup setting, press and hold SET-piston together with the ENTER-piston instead.



The same capture memory settings can be used for all available styles.

#### 4.5 Stops

The stops are activated via stop switches, pre-programmed memory locations or capture memory locations.

The lamp of the stop switch lights when the associated stop is active.

The stops are divided into the following groups:

**Pedal:** Activates the stops associated with the Pedal.

**Choir:** Activates the stops associated with the Choir.

**Great:** Activates the stops associated with the Great.

**Swell:** Activates the stops associated with the Swell.

**Solo:** Activates the stops associated with the Solo (*Ecclesia D-577 only*).

##### **Solo- and orchestral voices** (*optional*)

If the Instrument is equipped with the optional Solo or Symphony Voice Package a number of solo- and orchestral voices are available.

These solo- and orchestral voices are activated by thumb pistons on the piston rail between the manuals. The thumb piston light is on when the associated voice is active.

See chapter 6 OPTIONAL ORCHESTRAL PACKAGES for more information on solo- and orchestral voices.

Both Solo- and orchestral voices can be assigned to a piston with a manual of choice, adjusted to a desired volume and other option settings such as harmony

---

and octave. This can be changed via Quick Access, see § 4.12.3 Programming mode *Orchestral*, and via the *Johannus Menu*, see §5.11.

## 4.6 Couplers

### Manual couplers:

SWELL - GREAT:

Fully couples all keys of the Swell to the Great.

CHOIR - GREAT:

Fully couples all keys of the Choir to the Great.

SOLO - GREAT (*Ecclesia D-577 only*):

Fully couples all keys of the Solo to the Great.

SWELL - CHOIR

Fully couples all keys of the Swell to the Choir.

SOLO - CHOIR (*Ecclesia D-577 only*):

Fully couples all keys of the Solo to the Choir.

SOLO - SWELL (*Ecclesia D-577 only*):

Fully couples all keys of the Solo to the Swell.

### Pedal couplers:

GREAT - PEDAL:

Fully couples all keys of the Great to the Pedal.

SWELL - PEDAL:

Fully couples all keys of the Swell to the Pedal.

CHOIR - PEDAL:

Fully couples all keys of the Choir to the Pedal.

SOLO - PEDAL (*Ecclesia D-577 only*):

Fully couples all keys of the Solo to the Pedal.

### MB: Manual Bass (bass coupler)

Couples the Pedal monophonic to the Great. Only the lowest key that is played on the Great is coupled from the Pedal to the Great.

If only the lowest key of a chord is released, the pedal key activated by the Manual Bass function is dropped until a new lowest key is played.

Activate the Manual Bass with the MB piston.



It is advised not to use the Manual Bass while playing the pedal board to avoid double bass tones.

### CF: Cantus Firmus (melody coupler)

Cantus firmus: Latin for 'fixed voice' or in organs 'solo voice' or 'melody coupler'.

Couples the Swell monophonic to the Great. Only the highest key that is played on the Great is coupled from the Swell to the Great.

With use of a solo registration on the Swell in this way a solo is heard while playing only on the Great.

If only the highest key of a chord is released, the key activated by the Cantus Firmus function is dropped until a new highest key is played.

Activate the Cantus Firmus with the CF piston.



It is advisable not to use the Cantus Firmus in combination with the coupler SWELL - GREAT because this overrules the solo function of the Cantus Firmus.

## 4.7 Accessories

### **KT: Keyboard Transfer**

Keyboard Transfer is a function to switch the manuals and divisional pistons of the Choir and the Great. When Keyboard Transfer is active manual 1 is the Great manual and manual 2 is the Choir manual. See also Quick access function § 4.12.5.

Keyboard Transfer also switches the divisional pistons of the relevant manuals.

### **GEN. EXPR.: General Expression**

General expression, transforms the Expression pedal of the Swell into an expression pedal of the entire Instrument. The other Expression pedals will be switched off then. If no expression pedal is set as expression pedal of the Swell, this piston cannot be activated. See menu function Startup settings § 5.15.

### **SEQ: Sequence On/Off**

Sequence is a function for sequential selecting general capture memory locations.

1. Select a general capture memory location to start (for example level 2, location 2).
2. Pressing a random piston of the memory locations of the Pedal selects the previous general memory location, pressing a random piston of the general memory locations selects the next general memory location.

### **CAN.: Cancel**

Cancel is a function to switch off all stops at once.

### **REC: Recall**

Recall is a function to cancel the last change of registration. In this way it is possible to retrieve the last settings.

### **RO: Reeds Off**

Reeds Off is a function to switch off all reed stops simultaneously. As long as this piston is pressed, no reed stops can be activated. When this function is switched off, the reed stops that were on are activated again. Activate the Reeds Off with the RO piston.

### **MB: Manual Bass**

Couples the Pedal monophonic to the Great. Only the lowest key that is played on the Great is coupled from the Pedal to the Great.

### **CF: Cantus Firmus**

Couples the Swell monophonic to the Great. Only the highest key that is played on the Great is coupled from the Swell to the Great.

### **TRANS: Transposer**

The Transposer function shifts the pitch by half-tone increments (from -8 to +8). The set pitch can be read on the display (Transpose:..).

- 
- Press the TRANS. piston.
  - Use the - and + pistons to set the pitch.

### **CR: Crescendo**

Crescendo is a piston to activate the crescendo pedal.

If no expression pedal is configured as a crescendo pedal, the CR piston cannot be activated.

## **4.8 Capture memory**

### **4.8.1 Pre-programmed memory locations (PP – T2)**

Pre-programmed memory locations are available by operating pistons PP, P, MF, F, FF, T1, T2. These seven memory locations have factory settings (presets) appropriate for the quiet pianissimo to the loud tutti.

#### **Calling up a pre-programmed memory location:**

Press a pre-programmed memory location (PP-T2). The active stops light up.

#### **Programming a pre-programmed memory location:**



The current setting of the pre-programmed memory location will be lost.



Although it is possible to store any registration under a piston of a pre-programmed memory location it is advisable to select a registration matching the text of the piston.

1. Select the desired stops.
2. Press the SET piston. Hold the piston.
3. Press the desired pre-programmed memory location (PP-T2).
4. Release the SET piston.

### **4.8.2 Capture memory locations**

Through use of the capture memory, a registration can be made active with just one piston. The internal capture memory consists of 250 levels, can be seen on the display (M 1 to M 250), the level number can be increased with a quick press on the + piston and decreased with the - piston. When the + or - piston is pressed longer, the value changes faster.

Each level has eight general memory locations and eight separate memory locations for each division. With USB-memory the capture memory consists of 999 levels, can be seen on the display (U 1 to U 999 with the USB-memory symbol visible).

The levels stored in internal memory (M... on the display) and USB-memory (U... on the display) are different from each other.

Each level has eight general memory locations (general pistons 1-8) and eight separate memory locations per division (divisional pistons 1-8).



---

By pressing the SEQ piston, this sequence piston will be lighted. In this sequential mode each step within a level (M 1 to M 250, or U 1 to U 999) will be increased by pressing one of the general pistons (1-8), or decreased by pressing one of the pedal division pistons (1-8) – regardless of the number.

#### 4.8.1 Preloads

Level 1 of the capture memory is by default programmed with so called preloads, useful registration combinations, active after startup of the instrument. These preloads can be overwritten by the user but will be restored after a Memory Default operation. See § 5.12 Reset Procedures.

#### 4.8.2 Programming a capture memory location



The current setting of the capture memory location will be lost, either: internal memory M... or USB-memory U...

1. Select the current registration, with all desired couplers, stops and orchestral settings (for optional solo and symphony package), see “Stops” §4.5 and “Couplers” §4.6. When the registration is ready:
2. Use the - and + pistons to select a level (M 1-250) on the display, (U 1-999 with USB-memory connected, with  symbol visible on the display)
3. Press the SET piston. Hold the piston.
4. Press the desired memory location.
5. Release the SET piston.

#### 4.8.3 Calling up a capture memory location

1. Use the - and + pistons to select the desired level (M 1-250, or U 1-999) on the display.
2. Press the desired memory location. The active stops light up.

#### 4.8.4 Memory lock

The internal memory settings can be secured through a memory pin code, see § 5.9.

### 4.9 Transposer

The Transposer function shifts the pitch by half-tone increments (from -8 to +8). The transposer setting can be read on the display (Transpose).

1. Press the TRANS piston.
2. Use the - and + pistons to set the pitch.
3. When the transposer change needs to be saved, press the SET piston in the time the TRANS. piston is lit.

### 4.10 Crescendo pedal

The crescendo pedal can be used to activate 20 registrations step-by-step. These registrations start with very quiet (pianissimo) to very loud (tutti).

---

The default registrations of the 20 steps can be changed. See § 5.4 Crescendo.

#### **Activating the crescendo pedal**

If the crescendo pedal is not activated, the crescendo piston is not lighted. Use the CR piston to activate the crescendo pedal. The display indicates the actual step behind the crescendo symbol .

#### **Crescendo pedal as swell pedal**

The crescendo pedal can also be configured as a swell pedal. See § 5.5 Expression Pedals. If the crescendo pedal is set as swell pedal, all functions of the original crescendo pedal are deactivated.

### **4.11 Zimbelstern (optional)**

The Zimbelstern-piston is part of the optional Symphony package, see § 6.

It has a compass of 13 bells which are played in a certain sequence.

After switching on the Zimbelstern the sequence will sound automatically. You can't play the Zimbelstern by means of keys!

You have the choice out of four different sequences: two pre-selected, one random and one custom programmable sequence.

### **4.12 Quick Access**

Quick Access is a function to quickly access a certain function of the Instrument.

This function works in the following way: Press and hold the SET-piston and then press another second piston to enter a quick access menu, in the same way as for programming capture memory locations, see §4.8.2:

#### **4.12.1 Programming mode crescendo pedal**



This function is not available if no expression pedal is set as crescendo pedal.

Pressing the SET and CR piston simultaneously enters the programming mode of the crescendo pedal. See § 5.4 Crescendo, sub 4 for next steps.

#### **4.12.2 Programming mode MIDI**

Pressing the SET and one of the MIDI pistons simultaneously enters the programming mode of the MIDI Configuration. See § 5.10 MIDI Config for next steps.

#### **4.12.3 Programming mode Orchestral settings**



This function is only available if the Instrument is equipped with the optional Solo or Symphony Voice Package, see §6.

Through use of Quick Access it is possible to access the settings of a solo- or orchestral voice. An alternative voice can be selected and the voice can be assigned directly to a manual or the pedal.

Press the SET piston simultaneously with a piston of a solo- or orchestral voice. The actual choice of the voice and the manual assignment appears on the display. See § 5.11 Orchestrals for further steps.

The menu settings in Menu Orchestrals § 5.11 can also be changed by Quick Access. By press and hold one of the Orchestral voices and then press one of the general pistons 1-8, or +/-, SET or CAN-piston to change the settings of the selected voice during playing with combination:

<i>Press &amp; hold:</i>	<i>... and then press:</i>	<i>Change:</i>
An Orchestral voice	General piston 1	Harmony to Melody 1
An Orchestral voice	General piston 2	Harmony to Melody 2
An Orchestral voice	General piston 3	Harmony to Melody 3
An Orchestral voice	General piston 4	Harmony to Acc.
An Orchestral voice	General piston 5	Harmony to Bass 2
An Orchestral voice	General piston 6	Harmony to Bass 1
An Orchestral voice	General piston 7	Octave: down
An Orchestral voice	General piston 8	Octave: up
An Orchestral voice	+	Volume: up
An Orchestral voice	-	Volume: down
An Orchestral voice	CAN	Harmony to Full
An Orchestral voice	SET	Assign Keyboard*

Note: The keyboard can be assigned by pressing a key on one of the keyboards. All actual settings will be shown on the display when an Orchestral piston is activated.

#### 4.12.4 Programming mode Orchestral settings startup default



This function is only available if the Instrument is equipped with the optional Solo or Symphony Voice Package, see §6.

All manually changed, unsaved orchestral settings of the solo- and or orchestral voices will be lost when the instrument is turned off; see § 5.11 Orchestrals and § 4.12.3 for creating such solo and/or symphony voice settings. To make these settings as startup setting:

Simultaneously press the SET-piston together with the CANCEL-piston to save the current orchestral voice setting as the startup setting.

The orchestral settings can also be stored in the setzer memory, together with the registration, see setzer memory locations §.4.8.2.

#### 4.12.5 Programming startup mode

##### Keyboard transfer per Style

The default startup setting of the keyboard transfer can be programmed for each organ Style separately:

Press the SET piston simultaneously with the KT-piston to set the keyboard transfer for the currently activated Organ Style.

##### General Expression





The default startup setting of the Gen. Expr.-piston can be programmed: Press the SET piston simultaneously with the Gen.Expr.-piston.

---

## 5 JOHANNUS MENU

In the Johannus Menu several functions of the Instrument can be set. Press the MENU piston to activate the Johannus Menu on the display. Navigating the menu is done with the - and + pistons. Confirmation of a choice is done with the ENTER piston. Cancel or step back in the menu is done with the MENU piston.

The Johannus Menu consists of the following functions, presented in alphabetical order:

Function	More information
 Audio Settings	§ 5.1
Backup & Restore	§ 5.2
Chorus	§ 5.3
 Crescendo	§ 5.4
Expression Pedals	§ 5.5
General Volume	§ 5.6
Key Volumes	§ 5.7
Master Pincode	§ 5.8
Memory Pincode	§ 5.9
MIDI Config	§ 5.10
Orchestra (optional)	§ 5.11
Reset Procedures	§ 5.12
Reverb Settings	§ 5.13
Rotor Speed (optional)	§ 5.14
Startup Settings	§ 5.15
 Temperaments	§ 5.16
 Tuning	§ 5.17
 USB	§ 5.18
Version	§ 5.19

### 5.1 Audio Settings

Audio settings of headphones and aux-out can be changed:

1. Press the MENU-piston.
2. Use the - and + pistons to select the `Audio Settings` function on the display.
3. Press the ENTER-piston. The display shows Headphone/Aux Out.
4. Press the ENTER-piston to change the volume.  
The default HP/Aux Out level is 85%
6. Press the MENU-piston to exit the Johannus Menu.

Note: When a headphones plug is inserted, the headphones symbol  appears on the main menu. The loudspeakers will be silent when this symbol appears.

### 5.2 Backup & Restore

For Backup, or Restore of all settings, an USB-memory is necessary, with the **FAT32 file system**, 32GB or smaller size:

- Insert the correct USB-memory for Backup / Restore into the (type A) USB-connector. Make sure the (type B) USB for PC is not connected/used!

- When the display shows the USB-memory symbol , the USB-memory is recognized, see display image below:

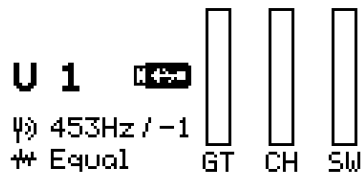

When USB-memory symbol is visible:

1. Press the MENU-piston.
2. Use the - and + pistons to select the Backup & Restore function on the display.
3. Press the ENTER-piston. The display shows both Backup and Restore choices.

```
Backup & Restore:
>Backup
  Restore
```

Use -/+, ENTER or MENU

4. Use the - and + pistons to select Backup, or Restore.
5. Press the ENTER-piston to confirm. Display possibilities are:

- Backup will continue after confirmation on the display:

<b>Confirm</b> Overwrite Backup OK? >Yes No	<b>Confirm</b> Create Backup? >Yes No
--	--

Use -/+, SET, ENT or MENU    Use -/+, SET, ENT or MENU

- Restore will continue after confirmation on the display:

```
Confirm
Restore?
>Yes
  No
```

Use -/+, SET, ENT or MENU

- 'Media Unavailable' message provided when no USB-memory is recognized.

6. Press the MENU-piston to exit the Johannes Menu.



**WARNING:** Keep the USB-memory inserted when Backup, or restore is in progress. And do not use the Instrument – This to avoid loss of

### 5.3 Chorus

Chorus is a function for lightly detuning the organ stops to give it a broader and livelier sound.

---

The chorus function can be activated/deactivated:

1. Press the MENU-piston.
2. Use the - and + pistons to select the `Chorus` function on the display.
3. Press the ENTER-piston. The display shows the choices.
4. Use the - and + pistons to select the choice (on/off).
5. Press the ENTER-piston to activate the selected choice.
6. Press the MENU-piston to exit the Johannus Menu.

## 5.4 Crescendo

If the Instrument has a General Crescendo, different registrations can be switched on in steps. These registrations start with very quiet (pianissimo) to very loud (tutti).

For this function, one of the Expression Pedals has to be selected as Crescendo pedal, see § 5.5.

When the crescendo is activated, by pressing the crescendo piston, the symbol  appears in the main menu of the display with the active crescendo step level.

### Changing the General Crescendo steps

The standard combinations of the crescendo steps can be changed and stored in memory, using the Menu:

1. Press the MENU-piston.
2. Use the - and + pistons to select the `Crescendo` function on the display.
3. Press the ENTER-piston. The display shows which type of crescendo (optional), or Crescendo steps (starting with Step 1).
4. The active programmed stops will appear and can be changed manually.
5. Confirm the desired choice with the ENTER piston. The display will show the next crescendo step. Add more stops and confirm the step with the ENTER piston again. Do this for each step.
4. Press the MENU-piston to exit the Johannus Menu.

The factory crescendo steps can be restored with the reset procedure, see § 5.12.



When a higher level of crescendo is programmed with less stops, than - When a stop is removed from a crescendo level, the same stop will also be automatically removed from the lower crescendo levels. And when a stop is added to a crescendo level, it will also be automatically added to higher crescendo levels.

## 5.5 Expression Pedals

The sequence and assignment of the Expression & Pedals can be changed in the Menu:

1. Press the MENU-piston.
2. Use the - and + pistons to select the `Expression Pedals` function on the display.
3. Press the ENTER-piston. The display shows the current Pedal assignment.

For example:

*GT/PD*      *Pedal 1*

*CH*          *Pedal 2*

---

*SW*            *Pedal 3*  
*Crescendo*   *Pedal 4*

4. Use the - and + pistons to select the Pedal that needs to be changed.
5. Confirm the desired choice with the ENTER piston, or press MENU to exit without adjustment. If needed, another Pedal can be selected and changed.
4. Press the MENU-piston to exit the Johannus Menu.



It is possible to let one pedal have more functions.  
Invalid options are automatically blocked.

## 5.6 General Volume

The volume can be changed from 0-100%. The master PIN code is required to adjust the general volume, see §5.8.

1. Use the - and + pistons to select the *General Volume* function.
2. Press the ENTER-piston. The current general volume appears behind *Volume*: The default value is 85%.
3. Use the - and + pistons to change to the desired volume level.
4. Enter to confirm or MENU to exit and discard changes.
5. Press the MENU-piston to exit the Johannus Menu.

## 5.7 Key Volumes

### a. Adjust

The Key Volumes 'Adjust' sub function makes it possible to adjust the key volumes of each stop per Organ Style while playing. The master PIN code is required to adjust the key volumes, see §5.8.

1. The first time it is recommended to press the CAN-piston, to switch off all stops and couplers.
2. Select an Organ style, see §4.4.
3. Press the MENU-piston.
4. Use the - and + pistons to select the *Key Volumes* function on the display.
5. Press the ENTER-piston. The sub functions of the Key Volumes menu appear on the display (*Adjust*, *Reset One stop*, *Reset all Stops*).
6. Use the - and + pistons to select the sub function *Adjust* and press the ENTER-piston. The display prompts for a stop or orchestral.
7. Activate one stop, or press one optional orchestral-piston. When selected, it gets a blinking status for the key volume adjustment. A question to press a single key appears on the display.
8. Press and hold a key of the corresponding division, or orchestral voice.  
All information of the pressed key is shown on the display:  
behind *Stop*: the active stop or orchestral,  
behind *Keyb*: the corresponding keyboard,  
behind *Key*: the actual key whose key volume can be changed:  
behind *Vol*: the actual 'key volume' of that key.
9. Press the pistons - or + (one or more times) to change the 'key volume' of the displayed key. While holding that key, you will hear the change in key volume and the display will show the new key volume level, which can be set from +24 dB to -24 dB (or off).

---

During the key volume adjustment it is possible to play the organ and activate more stops, orchestrals, keys, in which way the consonance can be heard. The last activated stop/orchestral/key will always be shown on the display to change the key volume – indicated by a flashing status of the register/orchestral.

10. Go to step 7 or 8 for the next stop/orchestral, key volume change, or press the SET-piston to save the (the interim) change(s), or press the MENU-piston to exit the menu.
11. If any changes have not been saved, the display will show `Discard changes?` Use the - and + pistons to select `Yes` for discarding and press the ENTER piston, or use the - and + pistons to select `No` if the changes still has to be saved and press the ENTER-piston.
12. Press the MENU piston two times to exit the Johannus Menu.



Only the 'key volume' of the stop/orchestral with the blinking status can be changed. The display shows the key information and actual key volume.



For resetting to default settings, refer to § 5.12 Reset Procedures.



Key volumes can also be adjusted using the optional Intonat program. The individual pitch tuning of each key can only be changed using Intonat.

#### **b. Reset one stop**

The 'Reset one stop' sub function resets the key volumes for one stop for one selected organ style to the factory setting. The master PIN code is required to adjust the key volumes, see §5.8.

1. Press the CAN-piston to switch off all stops and couplers (recommended).
2. Select an Organ style, see §4.4.
3. Press the MENU piston.
4. Use the - and + pistons to select the `Key Volumes` function on the display.
5. Press the ENTER piston. The sub functions of the Key Volumes menu appear on the display.
6. Use the - and + pistons to select the `Reset one stop` sub function on the display.
7. Press the ENTER-piston. A question to select a stop to reset appears on the display.
8. Activate one stop, or orchestral – this will get a blinking status indication. A question to confirm appears on the display.
9. Use the - and + pistons to select `No` or `Yes`.
10. Press the SET piston to confirm and to return to the Key Volumes menu.
11. Press the MENU piston two times to exit the Johannus Menu.

#### **c. Reset ALL stops**

The 'Reset ALL stops' sub function resets the key volumes of all stops in for one selected organ style to the factory setting. The master PIN code is required to adjust the key volumes, see §5.8.

1. Select an Organ style, see §4.4.
2. Press the MENU piston.



- 
3. Use the - and + pistons to select the `Key Volumes` function on the display.
  4. Press the ENTER piston. The sub functions of the `Key Volumes` menu appear on the display.
  5. Use the - and + pistons to select the `Reset ALL stops` sub function on the display.
  6. Press the ENTER piston. A question to confirm appears on the display.
  7. Use the - and + pistons to select `No` or `Yes`.
  8. Press the SET piston to confirm and to return to the `Key Volumes` menu.
  9. Press the MENU piston two times to exit the `Johannus Menu`.

## 5.8 Master Pincode

The following applicable functions can be protected from access, managed by the dealer and pincodes managed by the owner. The initial Master pincode can be found on the Quickstart, or known to the dealer. This concerns access to function menu's:

- General volume
- Key volume
- Reset procedures

When the keylock is 'unlocked', menu's can be accessed, without master pincode. Otherwise the master pincode provides access to menu's.

A new master pin code can be set by:

1. Use the - and + pistons to select the `master Pincode` function.
2. Press the ENTER-piston. A question appears:

```
Confirm
Set new master pincode?
Yes
>No
```

Use -/+ , SET, ENT or MENU

3. Use the - and + pistons to change.
4. Enter to confirm or MENU to exit and discard changes.
5. Press the MENU-piston to exit the `Johannus Menu`.

The Master Pincode cannot be changed by the user. Setting can only be done during installation, or be modified by the dealer, or Global Organ Group B.V.

When the correct memory pin code is entered, it is no longer necessary to enter this pin code again – as long as the Instrument is not switched-off.

## 5.9 Memory Pincode

The Memory Pincode protects the memory locations from being overwritten. Only users who know the Pincode can overwrite the memory locations. There are 250 memory locations in total.

1. Press the MENU-piston.
2. Use the - and + pistons to select the `Set Pincode` function on the display.

3. Press the ENTER-piston. The display shows the memory locations 1 – 250 for selection.
4. Use the - and + pistons to select the memory to create a new Pincode.
5. Press the ENTER-piston to confirm
6. Enter Pincode (initial factory generated default pincode is 1-1-1-1):
  - Use number pistons of Divisionals and generals to enter the Pincode
  - Press the ENTER-piston to confirm
7. Press the MENU-piston to exit the Johannus Menu.



Memory pincode does not work on the USB-memory locations, only on the internal memory locations.



With several organists, USB sticks can be used, on which everyone can store their own memory banks.

When the correct memory pin code is entered, it is no longer necessary to enter this pin code again – as long as the Instrument is not switched-off.

## 5.10 MIDI Config

MIDI is a protocol for communication between the Instrument and other devices, such as PC, Johannus MIDI Sequencer+ or other musical instruments.

The programmable MIDI stops allow you to control any module voice through any MIDI channel (1-16). The four parts of the programmable MIDI code are: Channel, MSB, LSB and Voice.

1. Press the MENU-piston.
2. Use the - and + pistons to select the `MIDI Config` function on the display.
3. Press the ENTER-piston. A question to select a MIDI stop to configure appears on the display.

Activate the MIDI stop which has to be configured. The settings of the corresponding MIDI stop appear on the display. A pointer is located in front of the value of the MIDI channel.



Via Quick Access the same menu appears on the display with: Press and hold the SET-piston and press a single MIDI piston of choice simultaneously with the SET-piston. Release both pistons.

4. Use the - and + pistons to select the desired MIDI channel.
5. Press the ENTER-piston. The pointer jumps to the MSB value.
6. Use the - and + pistons to select the desired MSB value.
7. Press the ENTER-piston. The pointer jumps to the LSB value.
8. Use the - and + pistons to select the desired LSB value.
9. Press the ENTER-piston. The pointer jumps to the Voice value.
10. Use the - and + pistons to select the desired Voice value.
11. Press the ENTER-piston. The selected configuration is now stored in memory. The pointer jumps back to the MIDI channel location.

- 
12. Press the MENU piston three times to exit the Johannus Menu.

### 5.11 Orchestrals (optional)

The optional Orchestrals are a set of individual orchestral pistons, which can be selected during play. For each orchestral piston, a specific orchestral instrument and keyboard can be assigned:

1. Press the MENU-piston.
2. Use the - and + pistons to select the `Orchestrals` function on the display.
3. Press the ENTER-piston. The display shows "Orchestrals", with a list of all available orchestral pistons.
4. Use the - and + pistons to select the desired Orchestral piston for change.
5. Press the ENTER-piston to confirm the selected choice. The display shows the selected orchestral piston name and all settings for this piston. The following settings are available:
6. Instr.: Use the - and + pistons to select: Instrument (Instr.) and press the ENTER-piston to confirm. With - and + pistons the desired Solo, or Orchestral instrument sound can be chosen. Press ENTER-piston to confirm.



Via Quick Access the same menu appears on the display with: Press and hold the SET-piston and press a single Solo or Orchestral piston of choice simultaneously with the SET-piston. Release both pistons.



It is possible to select another instrument, than written on the piston. Thus, for example: for the Solo piston 'Flute' also a sound of another Solo instrument of choice can be selected.



It is not possible to select a Solo instrument under an Orchestral piston, or an Orchestral instrument under a Solo instrument.

7. Keyb.: Use the - and + pistons to select Keyboard (Keyb:) and press the ENTER-piston to confirm. The cursor sign ">" moves to the right. Use the - and + pistons to select the desired Keyboard: Choir (CH), Pedal (PD), Great (GT), Swell (SW) and press ENTER-piston to confirm. The Orchestral piston will now be assigned to a selected keyboard.
8. Harmony: Use the - and + pistons to select Harmony and press ENTER-piston to confirm. Now, with the + and - pistons the type of 'harmony' settings can be changed: Full, this is without any automation, or automated harmony settings like: Melody 1 to 3 (Mel 1, 2, 3), accompaniment (Acc.), Bass 1, 2. Press ENTER-piston to confirm a setting.

Use of harmony settings: By selecting the correct instrument, keyboard and harmony setting, an intuitive way of automated solo voice(s) can be created to play different orchestral instruments on different keys at the same time on the same keyboard. For example: a violin on the highest key and an oboe on the second highest key. Parameters can be changed without using display menu's, during play via Quick Access, see § 4.12.3. The following settings can also contribute to subtle settings for use:

9. **Volume:** Use the - and + pistons to select the desired Volume and press ENTER-piston to confirm. Now use the - and + pistons to adjust the volume level and press ENTER-piston to confirm. See also Quick Access § 4.12.3 for changing this parameter while playing.
10. **Octave:** Use the - and + pistons to select the desired Octave and press ENTER-piston to confirm. Now, use the - and + pistons to select Normal, +1, +2, -1, -2 Octaves and press ENTER-piston to confirm. See also Quick Access § 4.12.3 for changing this parameter while playing.
11. Press 3 times the MENU-piston to exit the Johannes Menu.



It is possible to save a created setup, once a usable setup has been found, see Programming in capture memory § 4.8.2.

## 5.12 Reset Procedures

The Reset Procedures function is used to **delete the capture memory, or to reset a number of settings**. The master PIN code is required for the reset procedures, see §5.8.

1. Press the MENU-piston.
2. Use the - and + pistons to select the `Reset Procedures` function on the display.
3. Press the ENTER-piston. The display shows the menu for the Reset Procedures.
4. Use the - and + pistons to select the desired procedure:
  - **Crescendo default:** Resets the Crescendo to factory settings
  - **Cust. Temperament def.:** Resets the Temperament to factory settings
  - **Expression Pedal def.:** Resets the Expression Pedals to factory settings
  - **Memory default:** Clear the entire capture memory (reset to factory).
  - **Memory Pincode default:** Clear the pincode (reset to factory default).
  - **MIDI default:** Resets the factory settings of the MIDI stops (optional).
  - **Preset default:** Resets the factory settings of the fixed combinations.
  - **Reverb default:** Resets the reverb settings to default settings.
  - **Zimbelstern default:** Resets to the default zimbelstern settings.
  - **Orchestrals default:** Resets to the default Orchestrals settings.



**The selected settings will be deleted and set to factory default.** If you are not sure, press the menu-piston and make a backup, see §5.2 Backup & Restore.

5. Press the ENTER-piston. The display requests confirmation.
6. Use the - and + pistons to select No or Yes.
7. Press the ENTER-piston for confirmation
8. Press the MENU-piston to exit the Johannes Menu.



When the USB-memory is connected, a message will appear to disconnect the USB-memory.



To reset key volumes, see §5.7 b and/or c.

---

### 5.13 Reverb Settings

With the function Reverb Volume you can set the volume from 0-100%.

1. Press the MENU-piston.
2. Use the - and + pistons to select the `Reverb Volume` and/or `Reverb type` function on the display.
3. Press the ENTER-piston. With Reverb type a selection can be made of 12 convolution reverbs. With reverb Volume the amount of reverb can be adjusted.
4. Use the - and + pistons to select the between Reverb type and Reverb Volume.
5. Press the ENTER-piston to confirm.
6. Use the - and + pistons to select the Reverb type, or amount of reverb volume.
7. Press the ENTER-piston to confirm.
8. Press the MENU-piston to exit the Johannus Menu.

### 5.14 Rotor Speed (optional)

With this optional function the rotor speeds can be set for `Orchestral: Gospel Organ`, or `Jazz Organ`, only for models with optional `Symphony` package (see §6 `Optional Orchestral Packages`).

The rotor speed settings can be adjusted for both upper rotor (for tweeter) and Lower rotor frequency (for mid. Frequency), both fast RPM setting (tremolo) and slow RPM setting (Chorale) are affected. Short pressing the same `Orchestral`-piston, allows the rotor to switch between Tremolo or Chorale. A long press will de-activate the rotor function.

1. Press the MENU-piston.
2. Use the - and + pistons to select the `Rotor Speed` function on the display.
3. Press the ENTER-piston. Now parameter choices can be selected for Upper Tremolo, Upper Chorale, Lower Tremolo, or Lower Chorale:
4. Use the - and + pistons to select between choices.
5. Press the ENTER-piston to confirm.
6. Use the - and + pistons to adjust the rotor speed.
7. Press the ENTER-piston to confirm.
8. Press MENU-piston to exit the Johannus Menu.

---

## 5.15 Startup Settings

With this function default choices can be selected at power-on, these are: chorus on, Harp (damper, sustain and no pedal), Style, General Expression, Swell behavior and Save Orchestrals.

1. Press the MENU-piston.
2. Use the - and + pistons to select the `Startup Settings` function on the display.
3. Press the ENTER-piston. Now startup choices can be selected for:
  - Chorus (on/ off),
  - Harp (damper/ sustain/ no pedal), function with F# on the pedal board,
  - Style (NL-ROM/ EN-ROM/ FA-ROM/ AM-CLA/ SD-BAR/ ND-BAR) see § 4.4,
  - Gen. Expr. General Expression (on/ off) see Accessories § 4.7,
  - Swell (Realistic/ Linear) behavior of the swell pedal and
  - Save Orchestrals.
4. Use the - and + pistons to select between choices.
5. Press the ENTER-piston to confirm. The cursor sign ">" moves to the right.
6. Use the - and + pistons to select the choice (like: on/off)
7. Press the ENTER-piston to confirm.
6. Press the MENU-piston to exit the Johannus Menu.



The default startup setting for keyboard transfer at power-on can be set for each Organ Style separately, see 4.12.5 and § 4.4.

## 5.16 ⇄ Temperaments

The Temperaments function sets the temperament. The active temperament will be on the main display, behind the symbol ⇄.

### Selecting a temperament

1. Press the MENU-piston.
2. Use the - and + pistons to select the `Temperaments` function on the display.
3. Press the ENTER-piston. A list of available temperaments appears on the display. The pointer indicates the current temperament.
4. Use the - and + pistons to select the desired temperament.

You can choose from twelve temperaments:

- Equal (normal temperament)
- Young II
- Vallotti
- Kirnberger III
- Kirnberger II
- Neidhardt III
- Werckmeister III
- 1/6 Meantone (1/6 comma meantone)
- 1/5 Meantone (1/5 comma meantone)
- 1/4 Meantone (1/4 comma meantone)
- Pythagorean

---

Besides these, it is possible to configure a custom temperament:

- Custom (free programmable temperament)
  - Custom Programming (free programmable temperament)
5. Press the ENTER-piston to confirm the new setting and return.
  6. Press the MENU piston twice to exit the Johannes Menu.

### Programming a custom temperament

With this function it is possible to create a personal temperament. Every key can be detuned with increments of 1 cent. The minimum value is -32 cents; the maximum value is +32 cents.



Programming can be done using the Great middle octave and will automatically be calculated for all keys of the Instrument.

1. Press the MENU-piston.
2. Use the - and + pistons to select the `Temperaments` function on the display.
3. Press the ENTER-piston. A list of available temperaments appears on the display. The pointer indicates the actual temperament.
4. Use the - and + pistons to select the `Custom Programming` function.
5. Press the ENTER-piston.
6. Press and hold a key of the Great middle octave. The detune setting of the pressed key appears on the display. The given detuning is compared to the equal temperament.

#### Custom Programming

Note:

Cents:

Select a note on the  
Great middle octave or  
use -/+, SET or MENU

7. Use the - and + pistons to select the desired pitch of the pressed key.
8. If necessary repeat steps 6 and 7 for another key of the middle octave.
9. Press the MENU piston twice to exit the Johannes Menu.



Using the reset procedure `Cust. Temperament def.` the Custom Temperament can be reset to equal temperament. See §5.12 Reset Procedures.

## 5.17 $\Psi$ Tuning

The Tune function shifts the pitch in steps of 1 cent, from -50 till +50 cents. The frequency adapts automatically 427.5 Hz to 452.9 Hz. The active pitch setting in Hz can be read on the main display directly behind the tune symbol  $\Psi$ .

1. Press the MENU-piston.
2. Use the - and + pistons to select the `Tune` function on the display.
3. Press the ENTER-piston. The actual Tune setting appears in cents and Hz on the display:

### Tuning:

Tune: +31 cents  
447.9Hz

Use -/+, ENTER or MENU

4. Use the - and + pistons to select the desired pitch.
5. Press the ENTER-piston to program the new setting and to return to the Menu, or press Menu-piston to exit without changes.
6. Press the MENU-piston to exit the Johannes Menu.

## 5.18 USB

The USB menu has functions to copy, delete and format the USB-memory. The USB-menu can be used for USB-memory with a memory capacity of 4GB to 32GB and FAT32 file system. A pin code can be asked to carry out the action.

Note: When USB-memory is inserted and recognized, the USB-memory symbol  appears on the main display and the capture memory bank locations starting with an “U” will be loaded from USB Memory, instead of internal memory starting with an “M”.



Only USB memory with **FAT32 file system** can be recognized by the system. USB-memory with other formats cannot be recognized, whether any data is present or not.

### To copy a specific Memory bank from USB Memory to internal memory, or vice versa:

1. Press the MENU-piston.
2. Use the - and + pistons to select the **USB** function on the display.
3. Press the ENTER-piston.
4. Use the - and + pistons to select the function **Copy Memory Bank** and press the ENTER-piston.
5. Use the - and + pistons to select the options on the display, for the desired copy action.

For example, the selected parameters below will Copy the settings of internal bank M01 to USB Memory Bank U02. The contents of the selected “Bank:” on the selected “Copy to:” destination will be overwritten.

```
Copy Memory Bank
>Copy from: INTERNAL
Bank: M01
Copy to: USB
Bank: U02
Yes:[SET] No:[MENU]
Use -/+, ENTER or MENU
```



- 
6. Press SET-piston to carry out the selected copy action.  
A confirmation will appear on the display for a final verification of the copy action in plain text, for example:  
Copy INTERNAL M01 to USB M02 OK?
  7. Select the answer, Yes or No on the display with – and + pistons and press ENTER to confirm the copy command, or MENU to exit the menu.
  8. Press two times the MENU-piston to exit the Johannus Menu.

**To delete a Memory bank from USB Memory, or internal memory:**

1. Press the MENU-piston.
2. Use the - and + pistons to select the USB function on the display.
3. Press the ENTER-piston.
4. Use the - and + pistons to select function Delete Memory Bank
5. Press the ENTER-piston. The Display shows the bank, or banks that can be deleted. When the display shows Bank \*\*\*, this means that the banks are empty, nothing to delete.
6. Use the - and + pistons to select the bank for deletion.
7. Press SET-piston to delete the bank, or MENU-piston to exit the menu.
8. Press two times the MENU-piston to exit the Johannus Menu.

**To format USB Memory:**

1. Press the MENU-piston.
2. Use the - and + pistons to select the USB function on the display.
3. Press the ENTER-piston.
4. Use the - and + pistons to select one of the functions Copy Memory Bank, Delete Memory Bank, Format USB Memory
4. Use the - and + pistons to select the Format USB Memory function on the display.
5. Press the ENTER-piston. A warning appears.



**Format function will destroy all information on the inserted USB-memory. Use only USB-memory with a capacity of 4GB to 32GB!**

6. Press SET-piston to format inserted USB-memory, or MENU-piston to exit the menu.
7. Press two times the MENU-piston to exit the Johannus Menu.

## 5.19 Version

The Version of the firmware software, hardware and sample set information, can be checked by the user.

1. Press the MENU-piston.
2. Use the - and + pistons to select the Version function on the display.
3. Press the ENTER-piston. The display shows the version information.
4. Use the - and + pistons to step through the information pages.  
When the USB Memory is connected, active before activating the MENU, it is possible to save the version information as text file on the USB Memory by pressing the ENTER piston on the last information page.
5. Press the MENU-piston to exit the Johannus Menu.

---

## 6 OPTIONAL ORCHESTRAL PACKAGES

If the Instrument is equipped with the optional Solo or Symphony Orchestral Package, a number of solo- and orchestral instrument library voices are available.

### Solo Voice Package

consists of the following solo voices:

<i>Flute</i>	<i>Trumpet</i>	<i>Oboe</i>	<i>Violin</i>
Piccolo	Piccolo Trumpet	Bassoon	Slow Violin/Cello
Recorder	Muted Trumpet	Saxophone	Guitar
<i>Panflute</i>	<i>Tuba</i>	<i>Clarinet</i>	<i>Cello</i>
Panflute II	Trombone	English Horn	Contrabass
Bandoneon	French Horn	Bass Clarinet	Acoustic Bass

Each of the 8 solo voice-pistons can be selected and above instrument library voices can freely be exchanged and assigned to these pistons of choice via Quick Access. A preference selection has been made, where the engraving on the piston corresponds to the italicized Solo voices from this list. See also § 4.12.3 and Johannes menu §5.11 Orchestrals.

### Symphony Voice Package

consists of all solo voice-pistons, with the addition of the following Symphony orchestral library voices. The following instrument voices can be assigned to additional Orchestral-pistons:

<i>Chimes</i>	<i>Harpichord</i>	<i>Strings</i>	<i>Woodwinds</i>
Celesta	Harpichord II	Tremolo Strings	Full Orchestra
Carillon	Harp	Pizzicato Strings	Choir
<i>Piano</i>	<i>Gospel Organ</i>	<i>Brass</i>	Timpani
Xylophone	Jazz Organ	Horn Section	Percussion Set
Glockenspiel	Theater Organ	Slow Strings	<i>Zimbelstern</i>

The voices of the first seven Symphony voice pistons can freely be exchanged, assigned with above instrument library voices for each piston, except of the zimbelstern. A preference selection has been made, where the engraving on the piston corresponds to the *italicized* Symphony voices from this list. See also § 4.12.3 and Johannes menu §5.11 Orchestrals.

The zimbelstern is a fixed Orchestral piston and has its own set of parameter settings: RPM 1 to 100; Pattern: Sequence 1, 2, User programmable or random, see §4.11 Zimbelstern.



A piston of the Symphony Library (for example piston Piano) can be assigned to another voice of the Symphony Library (for example Strings). It is not possible to assign a Symphony piston to a Solo voice (like Trumpet).



All solo voices can be assigned to a solo piston.

Both Solo- and orchestral voices can be assigned to a piston with a manual of choice, adjusted in volume, octave and harmony function - which enables the organist to play polyphonic music

---

with different instruments with accompaniment possibilities. All instruments can be assigned to up to six voice parts per manual, resulting in the sound of a full orchestra.

Settings can be changed by the user via Quick Access, see § 4.12.3 Programming mode  
Orchestral settings and via the Menu, see §5.11 Orchestrals.

When Orchestral 'Gospel Organ', or 'Jazz Organ' is active, the Rotor speed can be switched between Tremolo (fast RPM) and Chorale (slow RPM) with by short press on the same Orchestral piston and switched off by a long press on that piston. The rotor speed parameters can be changed via Johannes Menu §5.14 Rotor Speed.

At the moment when Symphony Voice Package 'Piano' or 'Harp' is activated, the sustain function is assigned exclusively for the pedal key F# - this will be displayed on the display for a short moment. For 'Harp' default startup settings can be set, see § 5.15.



When special orchestral voices are active, where pedal key F# is used as sustain, this F# pedal key will not produce sound.

---

## 7 MAINTENANCE, TROUBLESHOOTING AND WARRANTY

### 7.1 Maintenance

#### Overview

Component	Maintenance	Frequency
Cabinet	Cleaning. See § 7.1.1	As required
Manuals	Cleaning and removing scratches. See § 7.1.2	As required

#### 7.1.1 Maintenance of the cabinet



Do not use furniture polish or teak oil to clean the cabinet of the Instrument.  
Direct sunlight may discolor the cabinet.

1. Clean the cabinet with a damp cloth.
2. Rub the cabinet dry with a lint-free cloth.

#### 7.1.2 Maintenance of the manuals

The manuals are in the standard version - Synthetic.



Do not use aggressive cleaning agents such as paint thinner or acetone to remove dirt.

1. Clean the manuals with a damp cloth.
2. Rub the manuals dry with a lint-free cloth.
3. Remove any scratches with car polish.

---

## 7.2 Problems

### Overview

Symptom	Cause	Solution
Pedal board does not work properly	The pedal magnet is making poor contact with the magnetic switch at the rear of the pedal front cover.	Reposition the pedal board, See § 2.4.
Pedal board F# key does not work properly	An Orchestral voice, such as Gospel Organ, or Piano is active, where the pedal F# key has a function, see §6 Optional Orchestral packages.	Deactivate the Orchestral voice piston with the pedal F# function; see § 5.15.

## 7.3 Warranty

The conditions are specified in the warranty certificate. The warranty is void if changes or repairs are made to the Instrument by persons or organizations that are not authorized by Global Organ Group b.v.

## 8 MIDI IMPLEMENTATIONS

### 8.1 MIDI Implementation Chart

JOHANNUS Organs

#### MIDI Implementation card

Date: September 2008  
Version 1.00

Functions		Transmitted	Recognized	Remarks
<b>Basic Channel</b>	Default Changes	See MIDI Specs See MIDI Specs	See MIDI Specs Y <sup>1</sup>	See MIDI Specs
<b>Mode</b>	Default Messages Altered	Mode 3 N * * * * *	Mode 3 N N	
<b>Note Number</b>	True Voice	36 - 96 * * * * *		
<b>Velocity</b>	Note ON Note OFF	9nH v=1 - 127 9nH (v=64) 9nH (v=0)	9nH v=1 - 127 9nH v=1 - 127 9nH v=0, 8nH v=*	Velocity ON Velocity OFF *=irrelevant
<b>After Touch</b>	Keys Channels	N N		
<b>Pitch Bend</b>		N		
<b>Control Change</b>	7 11 100/101/6 100/101/6	Y Y Y Y		General Volume Expr. pedals Pitch Transposer
<b>Program Change</b>	: True#	See MIDI Specs * * * * *	See MIDI Specs See MIDI Specs	See MIDI Specs See MIDI Specs
<b>System Exclusive</b>		See MIDI Specs	See MIDI Specs	See MIDI Specs
<b>Common</b>	: Song Pos : Song Sel : Tune	N N N	N N N	
<b>System Real Time</b>	: Clock : Commands	N N	N N	
<b>Aux</b>	: Reset All Contr. : Local ON/OFF : All Notes OFF : Active Sense : Reset	N N Y N N	N N Y N N	
<b>Notes</b>	<sup>1</sup> Depends on number of divisions			

Mode 1: OMNI ON, POLY  
Mode 3: OMNI OFF, POLY

Mode 2: OMNI ON, MONO  
Mode 4: OMNI OFF, MONO

Y=YES  
N=NO

---

## 8.2 MIDI Specifications

This paragraph describes the specifications on the MIDI Implementation Chart in more detail.

### Default basic channels (transmitted/recognized)

Ecclesia T-377/D-477:	1: Choir	Ecclesia D-577:	1: Choir
	2: Great		2: Great
	3: Swell		3: Swell
	4: Pedal		4: Solo
	12: Stops		5: Pedal
			12: Stops

### Basic channel changes (transmitted)

Can be programmed through the MIDI Config. § 5.10 MIDI Config.

### Control changes (transmitted)

Controller 7 (07h) General volume, with volume values 40 (28h) - 127 (7Fh).

Controller 11 (0Bh) Swell pedal, with volume values 55 (37h) - 127 (7Fh).

Controller 6 (06h) Pitch, with pitch values (21h) - 95 (5Fh).

Pitch value 64 (40h) = a = 440Hz.

The following applies to the pitch:

LSB 100 (64h) 1 (01h) and the MSB 101 (65h) 0(00h).

Transposer, with transposer values 56 (38h) - 72 (48h).

Transposer value 64 (40h) = a = 440Hz.

The following applies to the transposer:

LSB 100 (64h) 2 (02H) and the MSB 101 (65h) 0(00h).

### Control changes (recognized)

Controller 7 (07h) General volume, with volume values 0 (00h) - 127 (7Fh).

Volume values less than 40 (28h) are treated as 40 (28h).

Controller 11 (0Bh) Swell pedal, with volume values 0 (00h) - 127 (7Fh).

Volume values less than 55 (37h) are treated as 55 (37h).

### Program changes (transmitted/recognized)

Organ stops: Depends on the number of stops and the sequence of stops.

MIDI stops (programmable): 1-128. See § 5.11 MIDI Config.

### System exclusive messages (transmitted/recognized)

Each 'sys ex' (system exclusive) message largely looks the same. The first 7 bytes and the last byte are always the same. Only the value of the 8th byte varies. This is the 'sys ex message' that Johannus generally uses: F0 00 4A 4F 48 41 53 XX F7 (hexadecimal). The 'sys ex messages' described below only indicates the value of the 8th byte (XX) and the output from which it is transmitted.

### All stops off

The 'all stops off' sys ex code is 7F. This sys ex code is transmitted through the MIDI SEQ. output when the cancel piston (CAN) is pressed. When an 'all stops off' sys ex code is received, all stops on the instrument are switched off.

---

**Pushbutton values**

When a piston is pressed, a sys ex code is transmitted with the value of the piston that is pressed (for example PP = 00 P = 01) through the MIDI MOD. output.

These sys ex codes are only important when the Johannus sound module CSM 128 is connected to your instrument.

**Other MIDI codes (transmitted)**

Press the cancel piston (CAN) to transmit the sys ex code, 'all stops off' and all volume settings through the MIDI SEQ. output.



## 8.3 Specifications of Instrument

This paragraph describes the specifications of the instrument.

Items for instrument type:		Ecclesia T-377	Ecclesia D-477	Ecclesia D-577
<b>Keyboards</b>	Manuals / voices	3 x 61 keys / 56 voices	3 x 61 keys / 65 voices	4 x 61 keys / 80 voices
	Pedalboard	32-note AGO pedal board with dark upper keys (or optional with plain upper keys) and pedal lights.		
<b>Audio System, internal amplifiers, External speakers, standard set</b> see §3.4.	Audio System	8.2	12.3	16.3
	Internal amplifier power	8 x 180W, 2 x 350W	12 x 180W, 3 x 350W	16 x 180W, 3 x 350W
	External loudspeakers	4 x UL 2800	6 x UL 2800	6x UL2800 + 4x UL2700
	External Subwoofer	2 x UL 3300	3 x UL 3300	2 x UL 3300 + 1 x UL 5000
<b>Connectors,</b> see §3.3 and §2	Phones jack	6.3 mm (Stereo)		
	Output jack	2x 6.3 mm (AUX OUT, Left, Right)		
	Input jack	2x 6.3 mm (AUX IN, Left, Right)		
	MIDI connectors	3 (In, MOD, SEQ)		
	USB port USB-memory / USB to PC	1 Memory port for USB-memory (up to 32 GB, FAT32 pre-formatted), 1 for PC		
	Fixed AC cable with connector	1		
<b>Orchestral packages (Solo/Symphony) Options,</b> see §6 Optional Orchestral packages	Standard	(without options: 'Solo package', 'Symphony package')		
	Solo package	Has option 'Solo package' (without 'Symphony package'), this includes only the 24 SOLO instrument voices of the SOLO library.		
	Symphony package	Has both options: 'Solo package', 'Symphony package', this includes all instrument voices of the SOLO library and SYMPHONY library, including Zimbelstern.		
<b>Organ Styles,</b> see §4.4 Organ Style	2 sets default, expandable to 6: American Symphonic, Dutch Romantic, English Romantic, French Symphonic, North German Baroque, South German Baroque.			
<b>Power consumption (nominal power)</b>	290 W, 80 W idle Mode	390 W, 85 W idle Mode	490 W, 90 W idle Mode	
<b>Operational Ambient Temperature Range</b>	32-113 °F; 0-45 °C.			
<b>Mains Supply Voltage,</b> See §2 installation	This instrument is adjusted to a mains supply voltage of: 220V, 230V & 240V 50/60Hz, or 100, 120V & 240V 50/60Hz. Before connecting the instrument, check if your mains voltage corresponds to the voltage indicated on the serial plate (see bottom below keyboards).			
<b>Console Dimensions</b>	Height without music rest	48.8 in (124 cm)	52.6 in (134 cm)	52.6 in (134 cm)
	Height including music rest	58.3 in (148 cm)	56 in (143 cm)	58.3 in (148 cm)
	Width	57.4 in (146 cm)	64.5 in (164 cm)	71.2 in (181 cm)
	Depth	29.3 in (75 cm)	29.3 in (75 cm)	29.3 in (75 cm)
	Depth with Pedalboard	46.3 in (118 cm)	47.6 in (121 cm)	47.6 in (121 cm)
<b>Weights</b>	Console	196 kg	158 kg	252 kg
	Bench	20 kg (or option: Bench with lift lid, 26 kg)		
	Pedalboard	22 kg		
	Total Weight	238 kg	200kg	294 kg

Specification v.1.00: In the interest of product improvement, the specifications and/or appearance of this Instrument are subject to change without prior notice. Please note that the actual dimensions and weight may differ slightly from this specification due to the woodwork and (internal) options.

---

For the USA: This device complies with part 15 of the FCC Rules. Operation is subject to the following two conditions: (1) This device may not cause harmful interference, and (2) this device must accept any interference received, including interference that may cause undesired operation.

This equipment has been tested and found to comply with the limits for a Class B digital device, pursuant to Part 15 of the FCC rules as documented for identified product above. These limits are designed to provide reasonable protection against harmful interference in a residential installation. This equipment generates, uses, and can radiate radio frequency energy and, if not installed and used in accordance with the instructions, may cause harmful interference to radio communications.

However, there is no guarantee that interference will not occur in a particular installation. If this equipment does cause interference to radio or television reception, which can be determined by turning the equipment off and then on, the user is encouraged to try to correct the interference by one or more of the following measures:

- Reorient or relocate the receiving antenna.
- Increase the separation between the equipment and receiver.
- Connect the equipment into an outlet on a circuit different from that to which the receiver is connected.
- Consult the dealer or an experienced radio/TV technician for help.

This equipment referenced in this declaration is identical to the Organ tested and found acceptable with the standards. The technical records maintained by the responsible party continue to reflect the equipment being produced under this Declaration of Conformity within the variation that can be expected due to quantity production and testing on a statistical basis.

This equipment requires shielded interface cables in order to meet FCC class B limit. Any unauthorized changes or modifications not expressly approved by the party responsible for compliance could void the user authority to operate the equipment.

For Canada: **NOTICE.** This Class B digital apparatus meets all requirements of the Canadian Interference-Causing Equipment Regulations.

**AVIS.** *Cet appareil numérique de la classe B respecte toutes les exigences du Règlement sur le matériel brouilleur du Canada.*

For C.A. US (Proposition 65): **WARNING.** This product contains chemicals known to cause cancer, birth defects and other reproductive harm, including lead.

## For China:

# 有关产品中所含有害物质的说明

本资料就本公司产品中所含的特定有害物质及其安全性予以说明。

本资料适用于 2007 年 3 月 1 日以后本公司所制造的产品。

## 环保使用期限



此标志适用于在中国国内销售的电子信息产品，表示环保使用期限的年数。所谓环保使用期限是指在自制造日期的规定期限内，产品中所含的有害物质不致引起环境污染，不会对人身、财产造成严重的不良影响。环保使用期限仅在遵照产品使用说明书，正确使用产品的条件下才有效。不当的使用，将会导致有害物质泄漏的危险。

## 产品中有毒有害物质或元素的名称及含量

部件名称	有毒有害物质或元素					
	铅(Pb)	汞(Hg)	镉(Cd)	六价铬(Cr(VI))	多溴联苯(PBB)	多溴二苯醚(PBDE)
外壳(壳体)	×	○	○	○	○	○
电子部件(印刷电路板等)	×	○	×	○	○	○
附件(电源线、交流适配器等)	×	○	○	○	○	○

○：表示该有毒有害物质在该部件所有均质材料中的含量均在 SJ/T11363-2006 标准规定的限量要求以下。  
×：表示该有毒有害物质至少在该部件的某一均质材料中的含量超出 SJ/T11363-2006 标准规定的限量要求。  
因根据现有的技术水平，还没有什么物质能够代替它。

## For EU:

### For EU Countries



- UK** This symbol indicates that in EU countries, this product must be collected separately from household waste, as defined in each region. Products bearing this symbol must not be discarded together with household waste.
- DE** Dieses Symbol bedeutet, dass dieses Produkt in EU-Ländern getrennt vom Hausmüll gesammelt werden muss gemäß den regionalen Bestimmungen. Mit diesem Symbol gekennzeichnete Produkte dürfen nicht zusammen mit den Hausmüll entsorgt werden.
- FR** Ce symbole indique que dans les pays de l'Union européenne, ce produit doit être collecté séparément des ordures ménagères selon les directives en vigueur dans chacun de ces pays. Les produits portant ce symbole ne doivent pas être mis au rebut avec les ordures ménagères.
- IT** Questo simbolo indica che nei paesi della Comunità europea questo prodotto deve essere smaltito separatamente dai normali rifiuti domestici, secondo la legislazione in vigore in ciascun paese. I prodotti che riportano questo simbolo non devono essere smaltiti insieme ai rifiuti domestici. Ai sensi dell'art. 13 del D.Lgs. 25 luglio 2005 n. 151.
- ES** Este símbolo indica que en los países de la Unión Europea este producto debe recogerse aparte de los residuos domésticos, tal como está regulado en cada zona. Los productos con este símbolo no se deben depositar con los residuos domésticos.
- PT** Este símbolo indica que nos países da UE, a recolha deste produto deverá ser feita separadamente do lixo doméstico, de acordo com os regulamentos de cada região. Os produtos que apresentem este símbolo não deverão ser eliminados juntamente com o lixo doméstico.
- NL** Dit symbool geeft aan dat in landen van de EU dit product gescheiden van huishoudelijk afval moet worden aangeboden, zoals bepaald per gemeente of regio. Producten die van dit symbool zijn voorzien, mogen niet samen met huishoudelijk afval worden verwijderd.
- DK** Dette symbol angiver, at i EU-lande skal dette produkt opsamlles adskilt fra husholdningsaffald, som defineret i hver enkelt region. Produkter med dette symbol må ikke smides ud sammen med husholdningsaffald.
- NO** Dette symbolet indikerer at produktet må behandles som spesialavfall i EU-land, iht. til retningslinjer for den enkelte regionen, og ikke kastes sammen med vanlig husholdningsavfall. Produkter som er merket med dette symbolet, må ikke kastes sammen med vanlig husholdningsavfall. Apparatet må tilkoples jordat stikkontakt.
- SE** Symbolen anger att i EU-länder måste den här produkten kasseras separat från hushållsavfall, i enlighet med varje regions bestämmelser. Produkter med den här symbolen får inte kasseras tillsammans med hushållsavfall. Apparaten skall anslutas till jordat uttag.
- FI** Tämä merkintä ilmaisee, että tuote on EU-maissa kerättävä erillään kotitalousjätteistä kunkin alueen voimassa olevien määräysten mukaisesti. Tällä merkinnällä varustettuja tuotteita ei saa hävittää kotitalousjätteiden mukana. Laite on liitettävä suojakoskettimilla varustettuun pistorasiaan.
- HU** Ez a szimbólum azt jelenti, hogy az Európai Unióban ezt a terméket a háztartási hulladéktól elkülönítve, az adott régióban érvényes szabályozás szerint kell gyűjteni. Az ezzel a szimbóllummal ellátott termékeket nem szabad a háztartási hulladék közé dobni.
- PL** Symbol oznacza, że zgodnie z regulacjami w odpowiednim regionie, w krajach UE produktu nie należy wyrzucać z odpadami domowymi. Produktów opatrzonych tym symbolem nie można utylizować razem z odpadami domowymi.
- CZ** Tento symbol udává, že v zemích EU musí být tento výrobek sbírán odděleně od domácího odpadu, jak je určeno pro každý region. Výrobky nesoucí tento symbol se nesmí vyhazovat spolu s domácím odpadem.
- SK** Tento symbol vyjadruje, že v krajinách EÚ sa musí zber tohto produktu vykonávať oddelene od domového odpadu, podľa nariadení platných v konkrétnej krajine. Produkty s týmto symbolom sa nesmú vyhazovať spolu s domovým odpadom.
- EE** See sümbol näitab, et EL-i maades tuleb see toode olemprügist eraldi koguda, nii nagu on igas piirkonnas määratletud. Selle sümboliga märgitud tooteid ei tohi ära visata koos olmeprügiga.
- LT** Šis simbolis rodo, kad ES šalyse šis produktas turi būti surenkamas atskirai nuo buitinių atliekų, kaip nustatyta kiekvienoje regione. Šiuo simboliu paženklinyti produktai neturi būti išmetami kartu su buitiniomis atliekomis.
- LV** Šis simbols norāda, ka ES valstīs šo produktu jāievāc atsevišķi no mājsaimniecības atkritumiem, kā noteikts katrā reģionā. Produkts ar šo simbolu nedrīkst izmest kopā ar mājsaimniecības atkritumiem.
- SI** Ta simbol označuje, da je treba proizvod v državah EU zbirati ločeno od gospodinskih odpadkov, tako kot je določeno v vsaki regiji. Proizvoda s tem znakom ni dovoljeno odlagati skupaj z gospodinskimi odpadki.
- GR** Το σύμβολο αυτό υποδηλώνει ότι στις χώρες της Ε.Ε. το συγκεκριμένο προϊόν πρέπει να συλλέγεται χωριστά από τα υπόλοιπα οικιακά απορρίμματα, σύμφωνα με όσα προβλέπονται σε κάθε περιοχή. Τα προϊόντα που φέρουν το συγκεκριμένο σύμβολο δεν πρέπει να απορρίπτονται μαζί με τα οικιακά απορρίμματα.

**CE** This product complies with the requirements of EMCD 2014/30/EU, LVD 2014/35/EU and Electromagnetic Compatibility Regulations 2016, Electrical Equipment (Safety) Regulations 2016.





